



The future

Low Voltage Protection and Communications

A First Tier Low Carbon Networks Fund Project

Closedown Report

June 2015



CONTENTS

1	EXECUTIVE SUMMARY	4
1.1	Aims	4
1.2	Methodology	4
1.3	Outcomes	4
1.4	Key learning	4
1.5	Conclusions	4
2	PROJECT BACKGROUND	5
3	PROJECT SCOPE	5
4	SUCCESS CRITERIA	6
5	DETAILS OF WORK CARRIED OUT	6
5.1	IEC protection curves	6
5.2	Cold load pickup and protection	7
5.3	3-Phase ganged operation	10
5.4	Long-range protection	10
5.5	Directional protection	14
5.6	Communications protocol	17
6	PROJECT OUTCOMES	18
6.1	IEC protection curves	18
6.2	Cold load pickup and protection	19
6.3	3-phase ganged operation	20
6.4	Long-range protection	20
6.5	Directional protection	24
6.6	Communications protocol	26
7	PERFORMANCE COMPARED TO AIMS	27
7.1	The project will deliver a new set of protection functions which will allow greater protection of the future LV networks	27
7.2	The project will deliver the method to calculate the settings to be applied to the different network configurations	27
7.3	The project will deliver a communications system to allow these to be altered remotely	27
8	REQUIRED MODIFICATIONS	27
9	VARIANCE IN COSTS AND BENEFITS	28
9.1	Costs variance	28
9.2	Benefit variance	28
10	LESSONS LEARNT	29
11	PLANNED IMPLEMENTATION	29
12	FACILITATE REPLICATION	29
	APPENDIX 1: SIMPLIFIED CIRCUIT MODEL LONG RANGE PROTECTION SIMULATION RESULTS	30
	APPENDIX 2: TRANSIENT LOAD SURVEY	35
	APPENDIX 3: BORSDANE AVENUE – BRIDGEWATER STREET CURRENTS AND VOLTAGES IN LOAD AND FAULT SCENARIOS.	37

VERSION HISTORY

Version	Date	Author	Status	Comments
1	22/06/15	Geraldine Bryson	Issued	

1 EXECUTIVE SUMMARY

1.1 Aims

This project developed and tested enhanced protection and communication functionality to be applied to the Kelvatek load management devices, Weezap and Lynx. This enhanced functionality will allow greater control on the low voltage (LV) network thus facilitating the low cost adoption of low carbon technologies and further permit a more appropriate response for a range of faults as the network loads change.

1.2 Methodology

The Weezap is a low voltage circuit breaker which can be installed in the place of a fuse without need for modification to the fuse carrier and the Lynx device is a low voltage switch which can be installed in a standard link box to join together two feeders. Whilst the devices can provide benefit from independent operation it was recognised that to deliver more benefit from the use of these devices it was necessary to develop communications to allow remote control and enhanced protection to facilitate their coordinated operation and to cover both radial and meshed configurations.

Kelvatek used data from field measurements and knowledge of how protection operates at other voltage levels to develop the protection functionalities. These new algorithms were tested via both simulation and field testing either on the Kelvatek test network or the Electricity North West distribution network.

The communications protocol was developed jointly by Electricity North West and Kelvatek. The functionality of this was tested on the Electricity North West test network management system.

1.3 Outcomes

The project has successfully demonstrated enhanced protection functionality which can be applied to the Weezap devices. This enhanced functionality can provide greater protection for low level faults at the end of longer feeders and can protect against expected issues such as cold load pickup following a prolonged outage on a network with high concentration of heat pumps.

The project has successfully implemented DNP3 communications between the Kelvatek Weezap or Lynx devices and the Electricity North West control room management system. This communications link allows integration of the LV technologies within the SCADA facilitating both the remote control of the devices and transfer of status and measurement data from the device to the Kelvatek server for analysis.

1.4 Key learning

The project successfully delivered a number of advanced protection algorithms and a communications platform for the Kelvatek devices. These algorithms are now available on the Weezap and Lynx platform and are applicable to all UK DNO networks.

The communications and protection developed as part of this project will be deployed as part of the Second Tier project, Smart Street. Further measurements captured as part of Smart Street will allow continued development and improvement of the protection algorithms.

1.5 Conclusions

Electricity North West and Kelvatek have successfully developed new communication and protection functionality which can be applied to the low voltage network. The new protection algorithms will provide protection for faults in both radial and meshed configurations as well as coping with the changing loads associated with low carbon technologies.

2 PROJECT BACKGROUND

This section reproduces the 'Problem' and 'Method' as stated in the original project registration.

The introduction of low carbon technologies such as photovoltaics (PV) has meant that low voltage (LV) networks have become more active with frequent changes in power flow. In order to meet the government's targets for carbon reduction consumers will install more LCTs including heat pumps and electric vehicles. With these new demand and generation technologies on the network the future load profiles and power flows will be dramatically different than those of today.

This will result in increasingly more complex networks which will require more complicated protection techniques that those delivered by the standard BS88 fuses used in today's networks.

Particularly there will be increasing levels of meshed networks in the future to cater for the additional loads which will require a more complex level of protection which may include distance protection. With this additional load comes the issue of cold load pickup following a HV fault ie all the load coming back on at once may result in overloaded assets. With existing fuse protection this could result in a fuse blowing and customer's experiencing a longer loss of supply.

Kelvatek have already developed with Electricity North West an LV circuit breaker which can be opened and closed remotely. This device may be used in meshing of networks to support increasing demand and generation. Currently the device is fitted with protection which replicated the BS88 fuse curves. This project will develop this protection further to cater for the networks of the future. The project will develop the devices to include:

- Mimic IEC fuse curves to provide better discrimination with HV devices
- Provide cold load pickup protection
- To provide fault protection during cold load pickup
- To allow 3 phases to operate in ganged mode
- To provide additional protection to those parts of the network beyond the reach of the fuse
- To provide directional protection from meshed networks
- Explore communications protocols to establish the most appropriate for LV networks
- Communications to allow all parameters to be changed remotely as well as provide remote operation of the devices.

3 PROJECT SCOPE

The 'scope' here is as stated in the original project registration.

The project will deliver a new set of protection functions which will allow greater protection of the future LV networks, the method to calculate the settings to be applied to the different network configurations and a communications system to allow these to be altered remotely.

The benefits of the project will be greater protection and control functionality for LV networks, particularly looking at catering for the expected increase in LCT installation.

4 SUCCESS CRITERIA

The following 'success criteria' are as stated in the original project registration.

Kelvatek have an LV test network which will be used to test the protection on different network configurations with different types of faults. The project will be deemed successful if the protection can be proved both by simulation and on the test network followed by successful deployment of a number of devices on the Electricity North West network to test stability under current conditions and successful remote communications using appropriate protocols.

5 DETAILS OF WORK CARRIED OUT

The project background (section 2) detailed a list of the individual protection and communication elements in scope. Each of these elements will be considered individually in the sections below.

5.1 IEC protection curves

IEC protection curves are typically used on high voltage (HV) devices whilst LV devices are typically protected with fuses. As fuse curves differ from IEC protection curves, there may be areas where the two curves cross and discrimination is not achieved. This could result in a HV device operating for a LV fault, it should be noted that these instances are very rare.

Therefore to aid in the discrimination between LV and HV devices, for these rare occurrences, there is a desire to be able to use IEC curves for LV protection and this may be done with an intelligent circuit breaker device such as the Kelvatek Weezap. An investigation of the IEC curves was performed using the Maple mathematics package. (Maple is a commercially available software package which can perform complex mathematical analysis.) The four main characteristics were analysed:

- Normal inverse
- Very inverse
- Extremely inverse
- Long-time inverse.

Each of these characteristics can be selected at different current settings, in a range from 100 – 400 amps. The time multiplier setting (TMS) may also be varied. An example of the results is shown in figure 1.

Figure 1: IEC curves

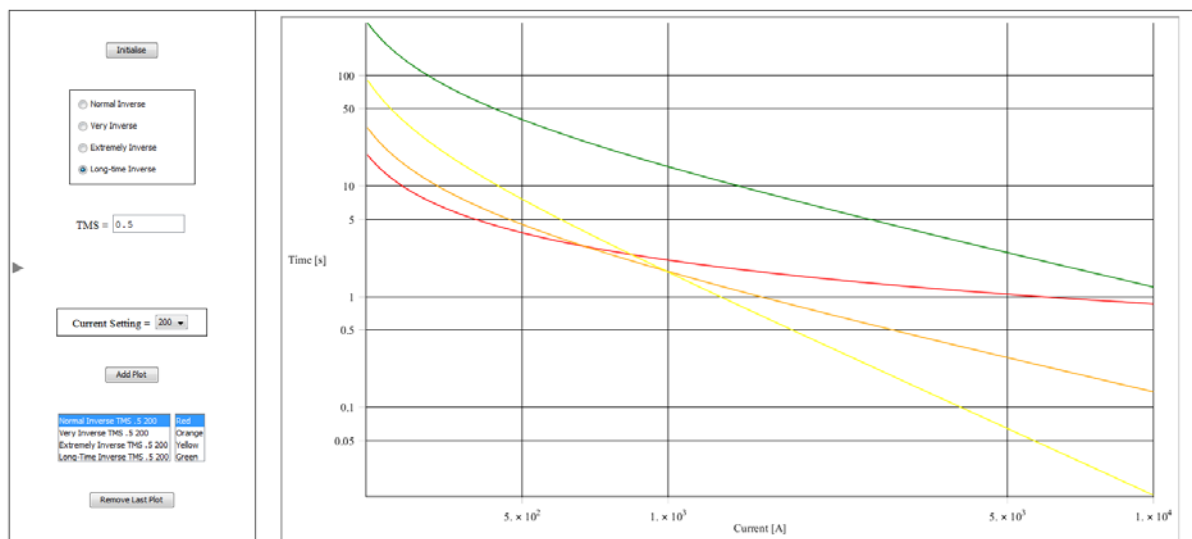

Here we can see the four main characteristics for the 200 amp level. Each characteristic has a distinctive shape.

With a 'reference' lookup table for each of the four main characteristics, each of the current levels can be emulated. This process is as follows:

- The input current level has a suitable current multiplier applied
- The reference lookup table for the particular characteristic is used to find the 'increment'
- This increment is scaled by a suitable time multiplier
- This value is then added to the counter
- If the counter reaches or exceeds the threshold, the Weezap 'trips'
- The counter value may decay if the current level drops.

The lookup table method is already used in Weezap fuse curves. The advantage of the scaling factors for IEC curves is that many protection settings can be emulated with just four lookup tables.

5.2 Cold load pickup and protection

5.2.1 Requirements

When an LV feeder is re-energised the amount of load picked up upon re-energisation depends on many factors. Traditionally, at low voltage, load diversity has resulted in only modest and short-term overload conditions, such that standard BS88¹ fuses have been able to pick up the load without risk of operating. However, as loads increase and the nature of some loads changes (ie loads associated with new low carbon technologies such as heat pumps) there is increasing risk that prolonged HV outages will result in subsequent LV outages when HV power is restored.

Three key factors considered relevant to the drivers for cold load pickup (CLP) are:

- The length of time without power
- The nature of the connected loads
- The local weather conditions at that time.

If a significant proportion of the load is electrically powered heating such as heat pumps, then any drop in temperature of the premises during an outage could result in all affected heat pumps demanding power as soon as supply is restored. The greater the penetration of heat pump schemes the greater this effect would be.

This situation is then made significantly worse during very cold weather and during long supply interruptions. The lower the ambient outdoor temperature the longer the heat pumps will take to restore the temperature in affected houses back to normal.

Kelvatek devices with overcurrent protection, such as Weezap, normally have a 'low set' protection characteristic in addition to the fuse emulation current-time characteristic. This 'low set' function operates at 60 seconds for currents over 145% of the nominal fuse setting. As a first step, it should be noted that that low set and cold load pickup are mutually exclusive. Hence, when CLP is active, low set must be temporarily disabled.

5.2.2 Practical limits of cold load pickup

The primary function of LV protection is to protect the LV cables from fault currents and prolonged overload which can cause damage to cables. If CLP is to be used to ride-through

¹ British Standard range of Low Voltage fuses used by DNOs.

higher than normal currents, care must be taken that the lifetime of the LV cables is not being significantly reduced. However, LV cables are quite resilient and are capable of withstanding considerable overload for at least the time required to restore normal load levels. The main limitation therefore in the level and duration of CLP possible is from the compact electronic devices capable of providing it, such as Weezap.

While the main switching capability in the 400A rated Weezap is provided by vacuum circuit breaker and thyristor technology, back-up protection is provided in series by an internal BS88 500A fuse. It would be undesirable for this fuse to blow while attempting to ride through a cold load pickup. The series backup fuse is operator replaceable, but would require an operator to attend the substation. Managing the risk of blowing the series fuse is a key part of the CLP functionality.

This back up fuse is designed to operate for faults above 8kA to protect the vacuum bottle which is only tested to this level. When designing the Weezap Kelvatek used the actual fault records obtained from other deployed devices such as Rezap and Bidoyng to assess how often the fault current was above 8kA. The results of this assessment showed that it would be highly unlikely for the back up fuse to operate.

With a view to finding the practical limits of CLP in a Weezap the limitations of the BS88 500A fuse was investigated. The time-current plot in Figure 2 illustrates the findings.

Figure 2: Cold load pickup curves

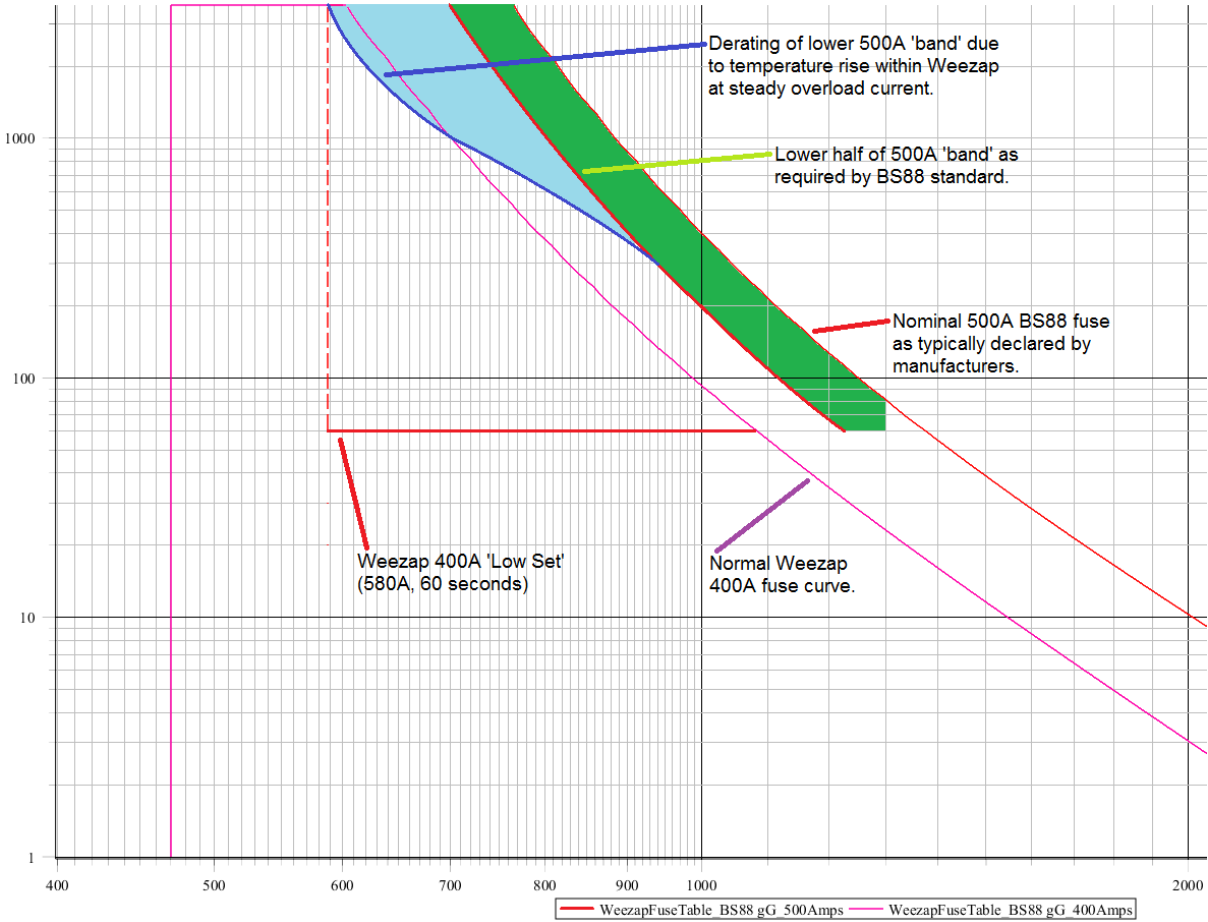

Fuses are not easy to manufacture to tight tolerances and the BS88 standard allows quite a broad band for each fuse. Hence, while fuse manufacturers may declare 'typical' fuse characteristics with varying tolerances, it is assumed that in practice a series fuse could be operating along the lower, faster limit of the band defined in the fuse standard. It is reasonable to assume that a fuse should not operate faster than this at normal ambient temperature.

However, fuses do need to be de-rated according to the local ambient temperature. Each manufacturer defines this de-rating slightly differently but one example is to de-rate by 0.5% for each degree above 40. The de-rating to be applied during CLP is complicated since the temperature of both the series fuse, the part of the device where it is mounted and the rest of the main current path through the device, will be changing (rising) whilst the overload persists. Temperature rise tests were conducted in a Weezap at a variety of overload current levels. From this a de-rated 500A fuse curve was estimated, assuming constant current and an ambient of 20°C. The result is shown in figure 2 by the blue line. With the low set turned off, the area below and left of the blue line is available for CLP functionality.

5.2.3 Implementation of cold load pickup overcurrent protection

A variety of ideas were investigated to find a simple, practical way of implementing a cold load pickup feature which:

- Allows what would normally be considered ‘overload’ current to flow for significantly more than the normal one minute ‘low set’ time
- Distinguishes between overload and real faults and clears genuine fault conditions
- Allows the ‘overload’ current to exceed the normal fuse characteristic
- Does not cause the series 500A fuse to operate.

As stated in 5.2.1, the first point is dealt with by simply making the active operation of the low set and CLP features mutually exclusive. There would also be a similar relationship between CLP and ‘long-range protection’. These two conditions are a matter of simple logic and are easily implemented.

The next point, clearing genuine faults, has two aspects. Firstly, there needs to be some current level above which the situation is dealt with as a fault – ie the normal overcurrent characteristic applies. This current limit is called the ‘CLPUpperCurrentLimit’. Below this current level a simple time limit would not be adequate; there needs to be some form of inverse time-current relationship. Initially it was thought that applying a cubic function to the rms current would give the desired behaviour but on closer examination this did not perform satisfactorily. Instead, a simpler, linear ‘overrating factor’ was introduced, which allowed the use of the same time-current characteristic as selected for non-CLP situations, but ‘overrated’ the lower part of this curve, up to the CLPUpperCurrentLimit, by a percentage. In practice this is achieved by multiplying the rms current by the inverse of the overrating factor. For example, overrating by 25% would result in the rms current being multiplied by 100/125 or 0.8. This is known as the CLPMultiplier.

It is clear that currents above the CLPUpperCurrentLimit will not be adjusted by this multiplier, allowing normal protection to be applied.

Next, the 500A series fuse must also be factored in. Since we are already using the modification of the rms current value to control behaviour in the CLP region of the time-current characteristic, it was decided to apply a temperature-dependent derating factor via the rms current value also. The Kelvatek Weezap in which the CLP feature was to be implemented, measures its internal temperature in several key places, giving an output with a resolution of 0.1 degree. One of these in close proximity to the internal fuse mounting position was chosen and the following derating formula applied:

$$\text{If Temp} > 40 \text{ then } I_{\text{rms}} = I_{\text{rms}} \times 200 / (240 - \text{Temp})$$

This function increases the rms current value by 0.5% for every degree above 40, effectively applying a derating factor to the time-current curve actively. Thus, as the Weezap, and hence the series fuse, heats up due to the cold load currents continuing to flow and the operating point of the fuse is reduced, there is a corresponding change in the operating point of the Weezap’s CLP protection, thus preventing the 500A series fuse from operating first.

Finally, in addition to the modified time-current curve, there is the need to have a definite maximum time for which CLP currents will be allowed to flow, at which point the operation of the device will revert to 'normal'. There is also a minimum current level associated with this, known as the CLPMinimumCurrent, above which the device will operate after this maximum time.

5.3 3-Phase ganged operation

The Kelvatek Weezap, Lynx and Modular Rezap are all single-phase switching devices designed for installation on three-phase systems. They are normally fitted as a set to all three phases but each device can operate independently, providing protection etc. as required by the conditions on the phase to which it is fitted.

Weezap and Lynx can be used for load management, and in this situation there is a requirement for all three devices to be opened or closed simultaneously. This is because load management systems are designed to deal with feeders and not individual phases. Under normal operating conditions all three phases of a feeder should be connected or disconnected together.

Communication to Kelvatek switching devices is achieved through a Kelvatek gateway, which is a local RTU to manage each of the devices. When a general 'all-phases' switching command is issued by the network management system, it can be received and interpreted by the gateway, which in turn can send three independent switching commands to each of the three devices, achieving the desired three-phase operation. This functionality would be in addition to any other single-phase or device specific switching operations.

Given that the nature of the system the switching command does not require synchronous switching of all three devices, there is no need to attempt to tightly co-ordinate the switching operation on each device.

5.4 Long-range protection

5.4.1 Long-range protection requirements

The first step was to determine the requirements for long-range protection, which are:

- To extend the protection capability beyond that of a fuse operating at the substation, such that cables towards the periphery of the network are better protected against fault conditions
- To operate in both radial and meshed configurations, with no previous knowledge of network configuration
- The protection must not rely on communication between devices
- Where possible, meshed circuits should be radialised to isolate faulty sections to keep the maximum number of customers connected
- Protection settings should be 'global' such that each network does not need to be analysed in detail to derive protection settings.

The fusing policy of Electricity North West states that faults occurring on underground cables should be cleared within 100s. The BS88 fuse curve family (implemented on the Weezap) was inspected, and the current threshold for each fuse curve to cause an operation after 100s was extracted. In general, this threshold is approximately 2.5 times the fuse rating (eg for a 400A fuse, this implies a 1000A fault current will blow the fuse after 100s). Therefore the initial consideration is that long-range protection must operate in less than 100s for currents which are lower than the threshold for a selected fuse setting. This would conventionally imply a large impedance path between the substation and the fault. However, considering a meshed network where a fault occurs near one Weezap, the current will exceed this threshold, and the device will operate within a short time. The fault will still be energised through the Lynx device, which will also need to operate to isolate the faulty section of the network. Therefore long-range protection must also consider faults which are

close to one of two meshed substations, not usually considered to be long-range in the radial network scenario.

In addition to the multitude of network scenarios over which a fault may occur, there are also three types of fault which are considered. They are:

- Welded (permanent short circuit)
- Arcing (continuous)
- Arcing (intermittent).

Work was conducted to study the characteristics of fault data and load data to identify the differences. (See Transient load survey below and in Appendix 2.) The outcome of this work was an understanding that each type of fault has its own characteristics, and therefore separate proprietary algorithms were designed to detect each type of fault.

In addition to the above fault detection algorithms, the protection also includes 'lowset overcurrent' functionality, which operates within 60 seconds. This offers enhanced protection for currents over 145% of the fuse rating which is a further improvement beyond that which a fuse offers, and covers a proportion of the tested scenarios. This has been fully tested in simulation and in practice.

5.4.2 Assumptions used in connection with long-range protection

In order to implement a solution to the requirements, several assumptions are made about the network being protected:

- Under normal switching circumstances, whereby two feeders are converted from radial to meshed or back from meshed to radial:
 - The switching will be done by closing or opening the Lynx, and not by switching either Weezap
 - All meshing connection operations are achieved by Lynx devices rather than fuses
- The fuse rating normally used for a radial feeder is the lowest value which the connected load will not exceed its rating, apart from cold load pickup or other abnormal situations
- Under operations, such as meshing up, the rating of normal fuse protection curves used will not need to change dynamically with the meshing or radialising of the feeders. It is also assumed:
 - Feeders would only be paired up for meshing if their main cable ratings from substation to Lynx are 'sufficiently similar'
 - Fuse ratings of paired-up feeders are 'sufficiently similar' or changed to be identical
 - No normal load situation exceeds the fuse rating for any prolonged period of time
- Any capacitors are switched in and out as 3-phase banks, all or nothing at each capacitor connection point
- All switching operations, including capacitors and meshing up, will be suspended if a feeder is deemed to be faulty and will not resume until the fault is found or assumed 'dormant'
- For meshed up feeders the voltage difference between the two substations will not be such that:
 - The current at either Weezap will exceed the fuse setting at either Weezap.

- The maximum voltage difference between substation busbars, combined with normal diversity of active loads, will cause through currents to exceed the rating of the lightest cable on the interconnection route
- Statutory voltage limits will be exceeded for any customer.

5.4.3 Long-range protection algorithm design

The long-range fault detection algorithms are based on the current increases seen at the three devices when the fault strikes. Obviously, loads switching in also cause increases in current, and therefore the algorithms must be able to discriminate between the two causes. Adjustable settings provide a trade-off between protection coverage and likelihood of falsely tripping on large loads. The current increase seen by the three devices is dependent on the network topology and the position of the fault within the network, so the devices can trip in any sequence. Therefore, a number of timing considerations are designed in to the algorithms to ensure that the fault circuit is isolated within the 100s time limit, regardless of the sequence in which the devices isolate the fault.

5.4.4 Long-range protection algorithm testing

The characterisation of the network behaviour under fault and load conditions is highly complex due to the infinite possibilities depending on the networks being connected. A simplified network is considered, shown in figure 3, in order to condense the complexity into an analysable model. In the model, the impedances and voltages can be varied to provide an array of possible network configurations which approximate the multitude of real-world possibilities. The switch points (ie Weezap, Lynx) can also be open and closed to determine the current flows as the network is sectionalised in different ways.

Figure 3: Simplified network model

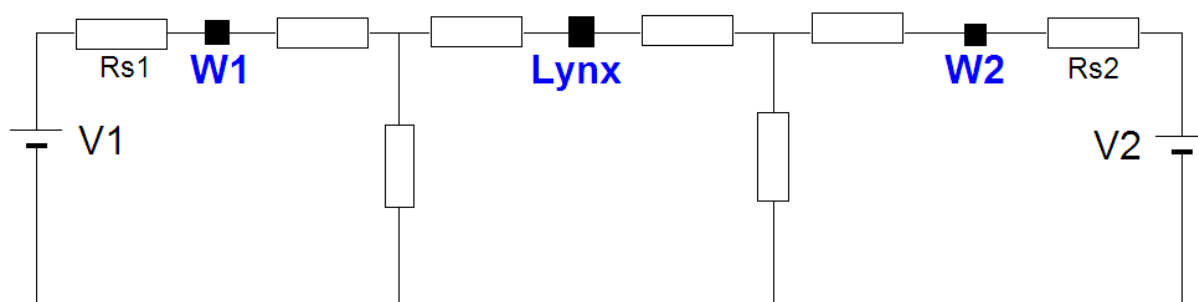

The fault is assumed to be in the network between Weezap 1 and the Lynx. A maximum voltage difference between substations in the meshed scenario of 4V is used. This was determined to be the largest voltage difference which could occur between two 500kVA transformers due to load imbalances on the two transformers such that the assumptions about the network voltages are upheld. In the analysis, $V1=V2+4$ was set, as the load flow through the network is the most challenging for this condition, ie this is the worst case condition for which the protection is required to operate.

Using the simplified network model described above, many test cases were analysed which demonstrate the capability of the long-range protection, and the limits of the coverage provided. In parallel, the behaviour of the conventional fuse for each network was calculated, such that the extension of the protection coverage enabled by these algorithms could be determined. The results of some of these studied cases are displayed in Appendix 1.

To further study the behaviour of the long-range protection algorithms, the performance was investigated in the context of a real-world example (Borsdane Avenue to Bridgewater Street), which is a network within the Smart Street project. All the calculations were performed by a bespoke network analysis tool, written in Maple, by Kelvatek. The calculations were based on those carried out in LVAFIRM (Electricity North West's LV network planning tool); however, this tool cannot simulate a meshed network, so needed to be extended.

Furthermore, the custom network analysis tool refines a number of calculations to more accurately model the behaviour of the network in the case of a long-range fault that draws low fault current. The layout of the network is shown in figure 4.

Figure 4: LV network for analysis

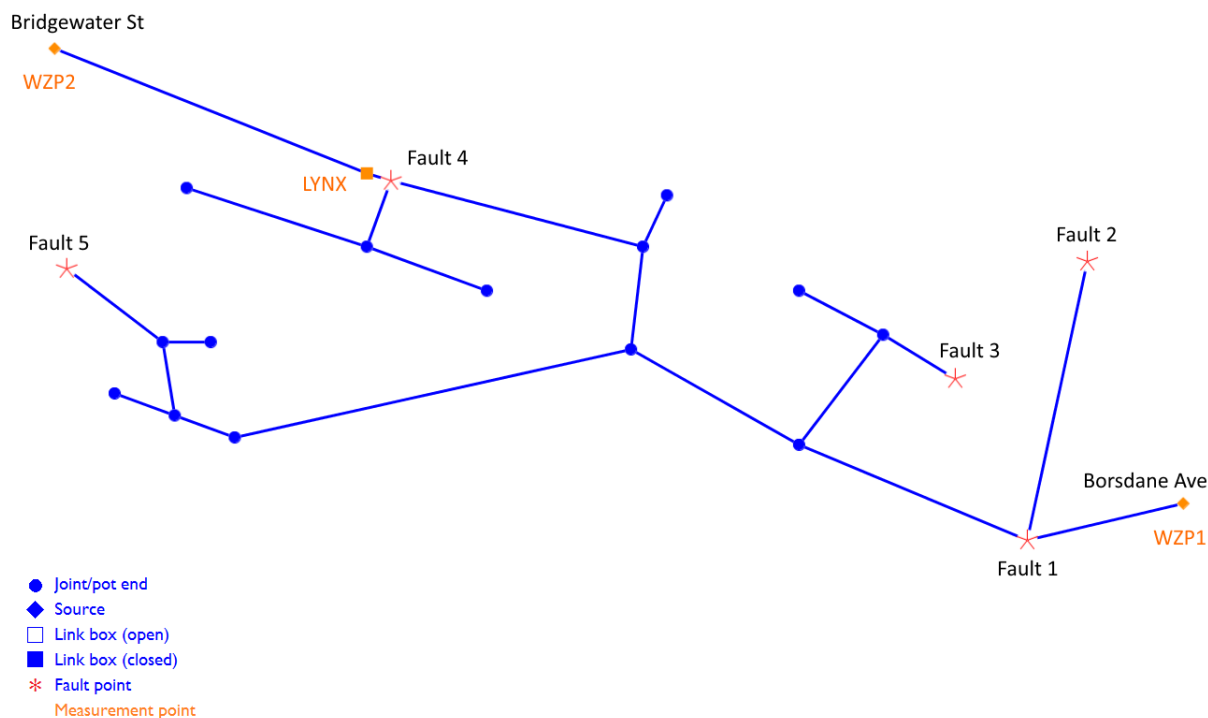

In every case, the combination of protection algorithms is able to isolate the fault, within 100s, while maintaining customer connection at the Bridgewater Street side of the link box. Further details of these experiments are shown in Appendix 3.

5.4.5 Transient load survey

A survey was undertaken to investigate the effects of load on the current draw and voltage level as measured at the substation. Kelvatek Weezap devices were installed at a number of Electricity North West substations.

For each installation, various parameters of the feeder, including whether it was domestic and if the customers used Economy 7, were recorded.

Weezaps typically record current and voltage when a fault current level is detected. For the transient load survey an additional trigger was required. This trigger needed to be capable of detecting when new loads are switched on and to record that new load level over a certain time window. The trigger should not cause recording when load current increases are very small or negligible. From these requirements, it was decided that a current step detection trigger was required. The trigger was designed specifically for this survey. Weezaps were set up to record both current and voltage when the step change in the RMS current level exceeds a threshold. The trigger will cause recording for a range of loads and load changes. The trigger has a minimum step size of 10 amps. It was assumed that steps smaller than this would be of no relevance to this study. For particularly 'busy' feeders there may be many loads frequently switching on and off. To ensure we would have a manageable amount of data, the step threshold was designed to automatically increase under such circumstances, so that an increasing proportion of small steps would be ignored but larger steps would still be captured. When the activity on the feeder reduces, the threshold gradually decays back to its default level.

Analysis algorithms were created using the Maple mathematics package. This allowed the separation of the different types of event recorded at each installation. The main event types were as follows:

- Steps
- Transients
- Spikes
- Large spikes

Three key parameters were calculated for each event – the start current, end current and the step size.

It was found that there was a significant amount of data captured over the course of the transient load survey. To reduce the data to a more manageable size, only data that had current steps larger than 20 amps were used for analysis. Step currents due to ‘closing’ could also be filtered out as required.

The relationships between start, end and step current, and also the loads on the feeder were analysed. The results from this study were used to form the basis of understanding to form long-range protection. Results can be viewed in Appendix 2.

5.5 Directional protection

5.5.1 Definition of ‘direction’ for overcurrent protection

On LV networks the protection normally takes the form of a simple fuse, which is dependent only on the amplitude of current over time and is bi-directional, or, rather, is insensitive to the fault direction. Most other forms of protection at LV deliberately mimic fuse behaviour and are also insensitive to the direction, basing their calculations solely on the rms current without regard to voltage or any other quantity.

This form of protection is adequate for traditional radial circuits where power can only flow from one source. With meshed feeders with at least two sources there could be the need for directional protection to allow more control over co-ordination and tripping sequences.

The concept of fault direction was investigated first in the simplified context of a single-phase circuit. When the direction of a fault is required, it is obvious that the current alone, being a sinusoidal quantity, does not provide sufficient information. The same is also true of the voltage. However, the direction of a fault can be determined by asking ‘which direction does the net real power flow?’ In a single-phase circuit this would be quite straightforward, needing only the instantaneous real power to be derived from the product of phase voltage and current. The fault loop can be approximated to a resistance and a reactance. The half-cycle average gives the net real power dissipated by the circuit and fault resistance. The averaging also removes a double-frequency oscillatory component of reactive power due to the circuit reactance. A positive net real power result would indicate that the fault lay on the feeder side of the device while a negative result would mean that the fault lay ‘behind’ the device.

5.5.2 Effect of close proximity faults on estimation of direction

Since the method of determining the direction of a fault or power flow depends upon the voltage as measured at the device, it is necessary to investigate what happens when a fault is very close to the device. If the voltage is too low then it may be possible for errors to swamp the true result, so that it must be accepted that there is some lower limit below which direction cannot be calculated reliably. In the extreme case a voltage of zero can’t give directional information at all, even in theory.

Two main ways of obtaining the voltage during a fault were considered. The first is to measure the voltage directly during the fault. This is simple but will be limited to cases when the voltage amplitude is high enough, ie voltage can only be measured during particular fault

conditions. The second method uses a kind of delayed measurement, such as a phase-locked-loop, to estimate the phase of the voltage during the fault based on what the voltage was before the fault occurred. While giving more scope this method is much more complicated. To decide which method was more appropriate for this purpose, the main aspects to consider are:

- Is the fault arcing or welded?
- What is the mode of the fault? (ie phase to neutral or phase to phase etc.?)
- Is the fault direction forwards or backwards relative to the device direction?
- Did the device close on to the fault or was it already closed?
- Will the device have time to beat the series fuse?

If the fault is arcing then there will always be a small but significant voltage available. Unlike HV faults, LV arcs form a higher proportion of the total fault loop voltage. For modes other than phase to neutral or three phase there will also be a voltage available at the device, since it measures the phase to neutral voltage. Combining these two considerations we see that the real problem lies with close-up welded phase to neutral or three phase faults because in these situations the voltage measured by the device will be very small and errors could be too big for direction to be reliable.

Now other aspects of the fault need to be considered. Given that directional protection is only relevant in a switching device, and mechanical switching operations always take time, there is a practical upper limit to the highest fault current that the device can clear without its series fuse operating. So, if a welded phase to neutral fault is forward of the device but very close, there will be a point where the series fuse will operate whether or not the device attempts to clear the fault or not. Beyond this distance, if there is sufficient impedance to limit the current to allow the device time to operate, there will also be some voltage drop on which directional calculations can be based. Hence there would be no need to 'remember' the voltage before the fault occurred in this case.

For a welded phase to neutral fault in the reverse direction there will be much more impedance in the fault loop even if the fault is very close to the device, so the series fuse of this device may not operate first in this case. However, if the fault lies beyond a second device on a second feeder fed from the same substation, the fault level available to that device will be such that its series fuse will operate first. If the fault is sufficiently far down the second feeder that the series fuse does not operate then there will be sufficient voltage for both devices to determine fault direction.

A case not covered is a welded busbar fault. Busbar faults are rare, but severe when they occur. If arcing, the direction will be available. If welded phase to neutral, it is most likely to have been caused during an outage and the device should not be allowed to close (assuming it were powered up). The case where a welded fault occurs on live busbars with the device already closed up is the only case where it would be necessary to 'remember' the pre-fault voltage.

Weighing all these factors up, it was clear that the relative simplicity of direct measurement greatly outweighed the limited need for a phase-locked-loop type voltage reference method.

5.5.3 Investigation of directional overcurrent protection in 3-phase circuits

With three-phase systems, while the principle of using the direction of power flow is the same as for single-phase, in practice there are several additional aspects to be taken into account. First of all, a fault can present itself in several different modes:

- Phase-to-Neutral (PN)
- Phase-to-Phase (PP)
- Phase-to-Phase-to-Neutral (PPN)
- Three Phase (3P) with or without neutral.

This is further complicated by the need to implement directional protection on single-phase devices such as the Kelvatek Weezap. This device only measures its phase voltage relative to neutral and has no direct input from other phases. For faults involving more than one phase, the product of current and phase-to-neutral voltage measured by one device will not give the total power. Furthermore, for phase-to-phase faults, the voltage reference used is not even in the circuit formed by the fault.

To understand the effects of the phase shift of 30 degrees leading or lagging of PP faults and how this combines with the varying power-factor angle of the fault loop itself, especially when viewed from the perspective of a single-phase device, a two substation, two meshed feeder simulation was created in MapleSim.

All three phases and neutral were modelled, to allow a variety of fault modes to be studied. Both feeders had lumped resistive load added to represent normal operating loads.

An overview of the simulation circuit can be seen in Figure 5.

Figure 5: Simulation circuit

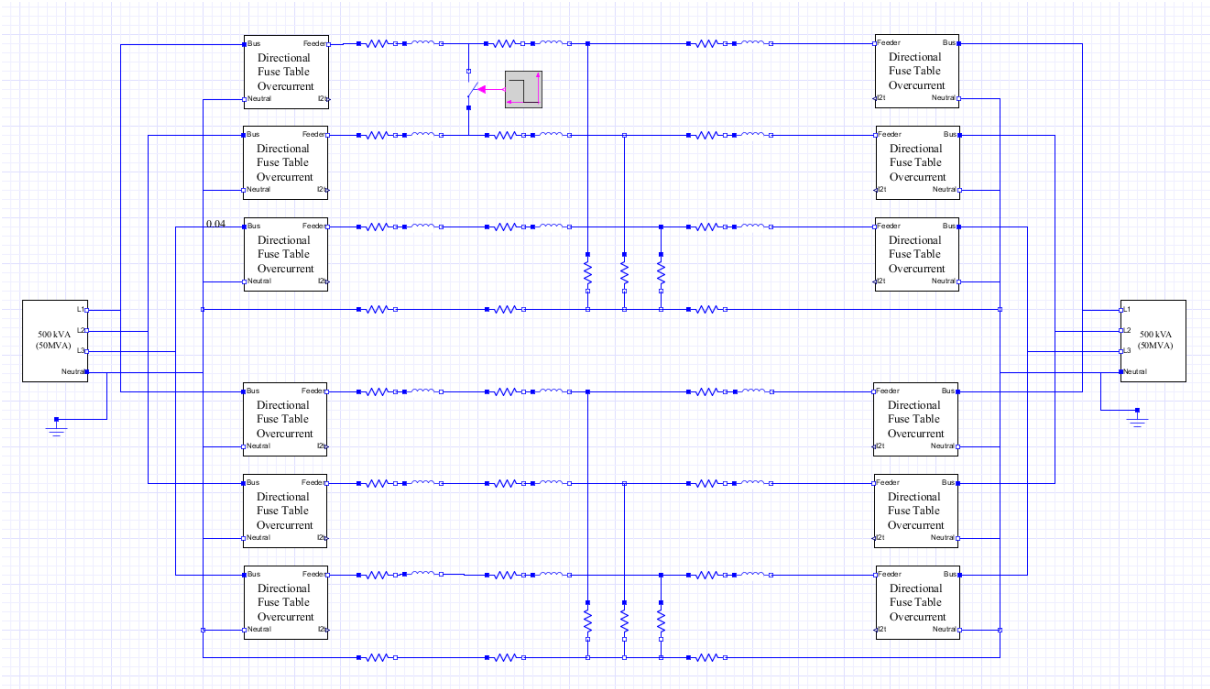

The two substations were modelled on 500kVA transformers such as are common in Electricity North West’s network. Impedance values were taken from the Electricity North West Code of Practice. The equivalent HV impedance was approximated to a simple inductance only. The entire simulation operated at LV, so that all impedances are referred to 240V.

The most of the functionality of a Weezap is deliberately excluded from the model; however, the emulation of the time-current characteristic of a 400A BS88 fuse is based closely on actual Weezap operation. The main difference, in addition to a directional element, is that the processing rate used in simulation has been reduced to 10ms, to allow less cumbersome analysis times.

Finally, the feeders themselves have been modelled on values taken from LV AFFIRM, with X/R ratio of approximately 0.5, typical of commonly used cable types and sizes such as 185 Waveform, 300 CONSAC or 0.2 inch Cu PILC. The results from this analysis can be seen in section 6.

5.6 Communications protocol

One of the objectives of the project was to provide a communication protocol to the Weezap and Lynx devices supplied by Kelvatek that is flexible and allows remote monitoring and control of the devices. The DNP3 protocol was chosen, a standards-based interoperability protocol used as communications between substation computers, RTUs and Intelligent Electronic devices (IEDs). A scan driver supporting the DNP3 protocol was developed for the Electricity North West Control Room Management System (CRMS).

5.6.1 Architecture

The Kelvatek Weezap and Lynx devices are installed either on the LV board or in an LV link box and communicate to a local RTU or gateway using a proprietary protocol over radio. The gateway collects data from the devices and communicates to the Electricity North West CRMS SCADA system. The gateway communicates via the Electricity North West Vodafone 3G/GPRS Access Point Name (APN) and supports the DNP3 protocol.

Figure 6: Communications architecture

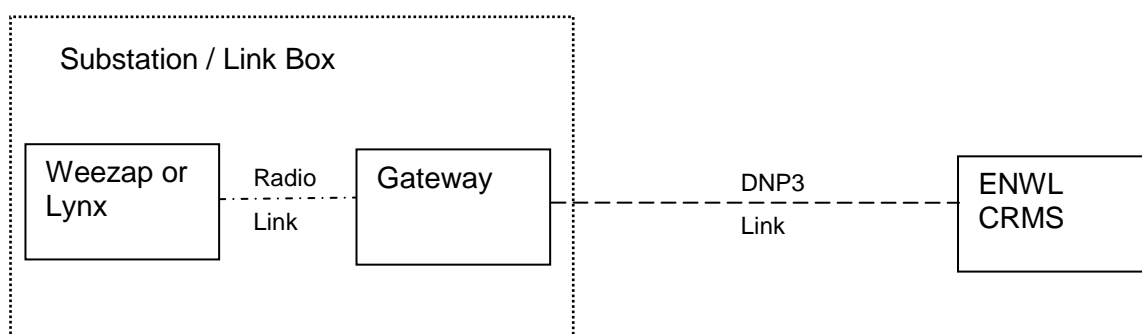

15 Kelvatek Weezaps can be connected to and report through one Weezap gateway and three Lynx devices can be connected to and report through one Lynx gateway.

The gateways are configured to send data to two systems, the Electricity North West CRMS and a Kelvatek central server. The Kelvatek central server is within the Electricity North West firewalls.

5.6.2 Configuration

The Electricity North West scan driver uses the Triangle MicroWorks DNP3 software library. This scan driver is configured as the master and the downstream gateways as the slaves. The master initially opens connections to each gateway and configures the number of IO points being retrieved by using DNP3 disable commands.

The master then addresses each gateway as an RTU outstation, each with a unique DNP3 address, and uses offset point addressing for the IO to be retrieved from each device connected to the gateway.

The Weezap and Lynx devices are configured to average the analogue values over a set period of time (60 second window in our application).

The gateway and the device configurations are managed at the central server.

5.6.3 Data monitoring

The DNP3 master connects to the slave gateways and the connection remains open (always on) ready for receipt of data. The devices report the averaged analogue values to the gateway at the end of each window. The gateway then generates events (even if values are the same) which are subsequently reported to CRMS.

Any digital signals are sent on state change, and the reporting of these changes is done as a priority over all other data transfers.

The data is stored in the CRMS database and processed by the alarm and event system. Standard analogue deadbanding is used to reduce analogue alarms.

The devices are displayed on the LV network diagram and show the states and values.

5.6.4 Field device control

The Kelvatek field device will automatically trip (open) on fault detection and will reclose for a transient fault. The device will perform a number of trips before it locks out (in this application the trips to lockout is 5). When the trips to lockout reach zero the device is locked in the open position.

These open/close states are received at by CRMS and an alarm is generated when the number of trips reaches a predefined level, for this application 2 was chosen.

The Weezap can trip several times during switching on the HV network for fault location and isolation and this may lead to the device reaching lockout. To avoid this, the device has been modified to detect the power failure from the HV and will not decrement the trip to lockout counter under this condition

For an LV fault the devices can be opened and closed from the CRMS restoration sequence to isolate the fault and restore customers.

When work is carried out on the LV network any device can be placed in local mode to avoid remote operations occurring.

5.6.5 Time synchronisation

The gateway performs NTP time synchronisation from an NTP server on the Electricity North West network, which enables the gateway to synchronise the devices (where the individual messages are time stamped). Currently the gateway time synchronisation occurs every 60 seconds by default but this is configurable.

After failure of the communications to a gateway a time synchronisation will be performed.

5.6.6 Failure conditions

Failure of the communications to a gateway marks all the device data points associated with devices on that gateway as bad quality at the master. Once the communications are restored the master does a synchronisation with the slave, including time synch and a full IO scan

Failure of a device marks the device data points as bad quality at the master. When the device is restored the gateway will update the time and normal scanning resumes.

6 PROJECT OUTCOMES

As with section 5 this section takes each of the elements in turn and discusses the results of the simulations and measurements.

6.1 IEC protection curves

The investigation into IEC protection curves included the four main characteristics of protection:

- Normal inverse
- Very inverse

- Extremely inverse
- Long-time inverse.

The investigation was performed using the Maple mathematics package. Each of the characteristics at various current levels could be tested and viewed on a comparison plot.

Unlike typical fuse curves, it is found that these IEC curves can be emulated with one lookup table per characteristic. The values of the input current and the increment values from the counter table can then be scaled to emulate the appropriate protection current setting. This method allows a myriad of protection settings to be emulated with just four lookup tables.

The lookup table method is compatible with the fuse curve work already implemented on Weezap.

6.2 Cold load pickup and protection

Cold load pickup functionality has been implemented on all relevant fuse settings from 100A to 400A. New settings for the upper and lower current limit within which CLP operation applies have been defined, together with a setting for the maximum time for which CLP can be active. A further setting controls whether CLP mode is enabled or disabled on a given device.

6.2.1 CLP overrating dependence on protection setting

The CLP time-current characteristic has been implemented in terms of the existing fuse time-current characteristic, extended to cover up to one hour, with a % overrating factor built in to the revised fuse tables. The overrating available for each protection setting is given in Table 1 below:

Table 1: Percentage CLP overrating per protection setting

Protection setting	Percentage overrating
400A	15%
355A	30%
315A	46%
250A	50%
200A	50%
160A	50%
125A	50%
100A	50%

The available overrating for CLP varies depending on the protection rating selected. This is because the upper limit imposed by the series 500A fuse, including its temperature dependence, is no higher for a 400A protection setting than for, say, a 200A setting. It depends purely on the electrical and thermal behaviour of the device and fuse, not the firmware or settings.

The % overrating for each protection setting has been selected based on this same upper limit for 400A, 355A and 315A. The lower settings have been all set to a maximum of 50% overrating to avoid excessive stresses on the cables etc. This could be adjusted depending on specific cable specifications and company policies but would always need to take the upper 500A fuse limit into account.

6.2.2 Test results for CLP temperature dependence

The operation of the temperature-derating aspect of the CLP functionality was tested on the most critical setting, 400A, at a variety of overload current levels. The test results, given in Table 2 below, demonstrate that the CLP algorithm derates for temperature appropriately, avoiding unnecessary operation of the series 500A fuse. For comparison, the theoretical trip time for CLP without temperature derating has been calculated, together with the trip time that would apply during normal, non-CLP operation.

Table 2: CLP temperature testing for 400A protection setting

RMS test current	CLP trip time inc. temp. derating (as measured)	CLP trip time without temp. derating (theoretical)	Normal trip time (CLP disabled)
600A	36 min 6 sec	1 hour	1 min (on low set)
700A	12 min 18 sec	54 min	1 min (on low set)
900A	5 min 37 sec	7 min 20 sec	1 min (on low set)

The results show firstly that, even with the limitations imposed by the series fuse at their worst for the 400A protection case, CLP mode does give significantly longer overload ride-through time than normal operation. Furthermore, comparing the theoretical non-derated CLP trip times with the actual derated trip times, it can be seen that the heating effect of the overload current does reduce the time to trip by an amount dependent on how much the temperature has risen.

For the 600A case, representing a 50% overload, there is a modest reduction because the heating effect is not severe, although heat will have had time to spread throughout the device. For the 900A case the reduction in trip time is also quite small because although the losses due to 900A are high, the thermal inertia of the Weezap device is such that there isn't sufficient time for the heat to flow from the resistive heat sources to the rest of the device. Hence the ambient temperature of the 500A fuse will not have risen much and trip time will not need to be reduced by much.

For the 700A case we get the worst combination, where heating effects are high and there is sufficient time for the losses to raise the device temperature significantly, and hence the ambient of the 500A fuse, so that CLP tripping must happen much sooner. However, even in this case we have dramatically more time than would normally be available without CLP.

6.3 3-phase ganged operation

All three-phase switching commands to devices will be routed through their gateway. The gateway will convert the general feeder or 'single-line-diagram' switching command into three independent commands for each specific device.

Device status is available individually before and after any switching operation.

6.4 Long-range protection

6.4.1 The algorithm

The algorithms for the three fault types are designed to operate on short time windows of RMS current data, deciding whether the window contains a fault which would require the protection to operate. A higher level algorithm accumulates the fault decisions and issues a trip command if the fault lasts for the specified period. The overall protection scheme is represented in figure 7.

Figure 7: Long range protection scheme

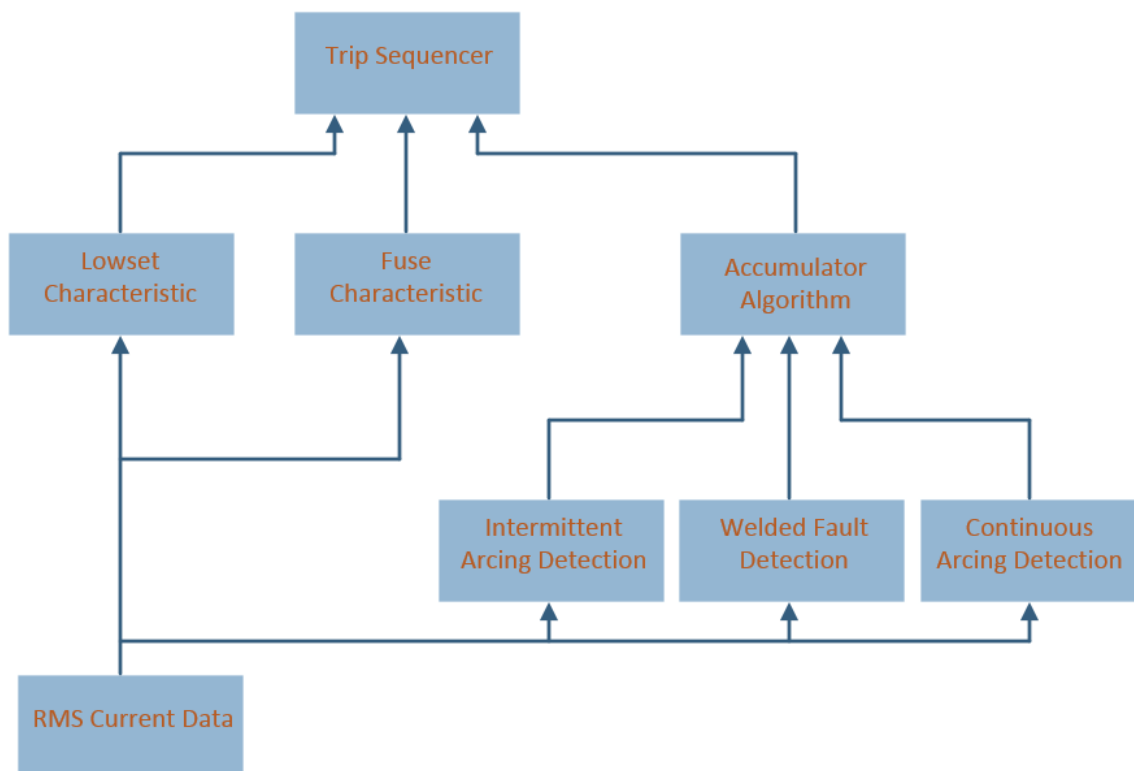

The outcome of the extensive simulations provides an appreciation of the capability of the long-range protection algorithms. In order to provide coverage to the main cable between the two sub-stations, the total phase resistance of the main cable between the sub-stations must be less than 0.4 Ohms, with the Lynx being centrally located along the path.

It has also been noted, that while manually tripping a Weezap in a meshed network would not be normal operational policy, doing so under light loading conditions is more likely to enable the Lynx to provide backfeed to the remainder of the network without falsely tripping due to the change in load current flow being interpreted as a fault condition.

6.4.2 Transient load survey

The transient load survey was undertaken at a number of substations to record step increases in load current. A total of 11 installations have had their data collected, filtered and analysed.

Figure 8 shows the data from the 11 installations. Due to the large amount of data recorded, data that had current steps less than 20 amps were deemed to be insignificant and dropped from the study.

Figure 8: Measured current data

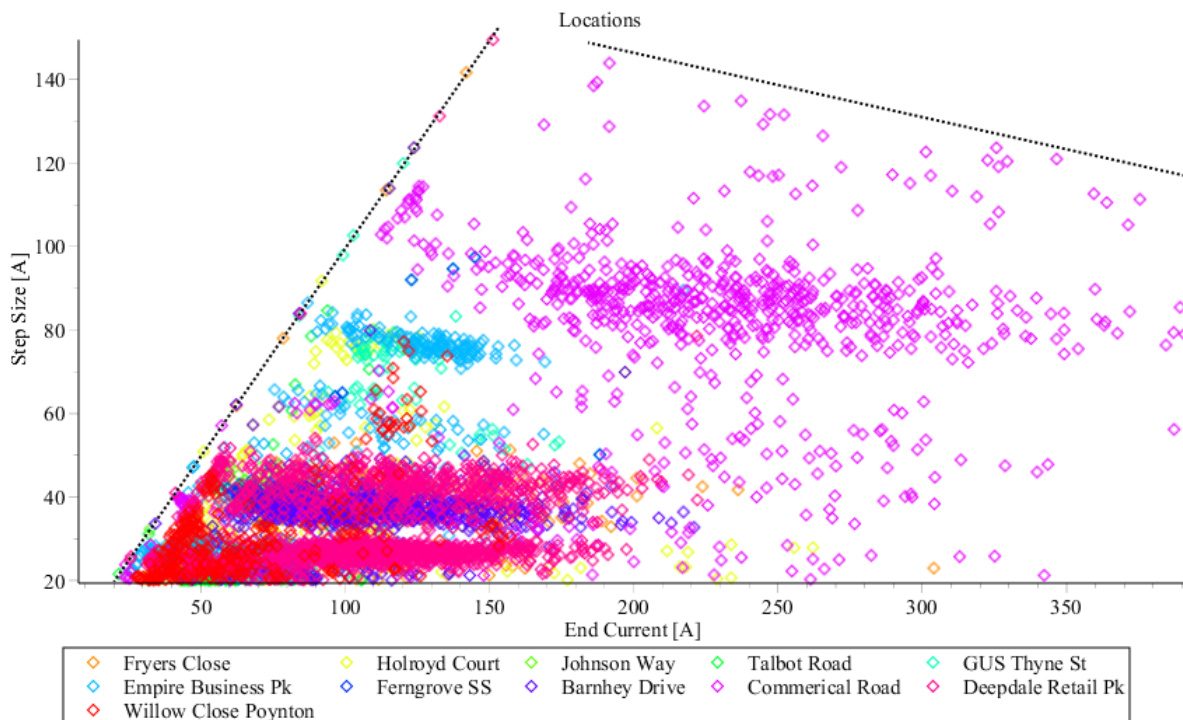

The plot shows the RMS current step size versus the RMS end current. The most obvious feature of the plot is the 1:1 diagonal line in the chart. This is simply due to the fact that the end current must be at least as large as the step size.

Each of the installations has a range of load current levels. Each installation has a reasonably well clustered spread of step sizes but the average step size varies dramatically between locations.

At higher end current levels, the maximum step sizes start to decrease. As a feeder reaches its load current capacity then most of the load is likely to be drawing current. In this case, there should be fewer loads left to switch on to drive large step increases in current.

The data contains 'close on' events, ie when the Weezap is closed on to the load. These events do not represent typical load changes and therefore may be removed. With the 'close on' events removed, the results are shown in Figure 9.

Figure 9: Measured current data with 'close on' events removed

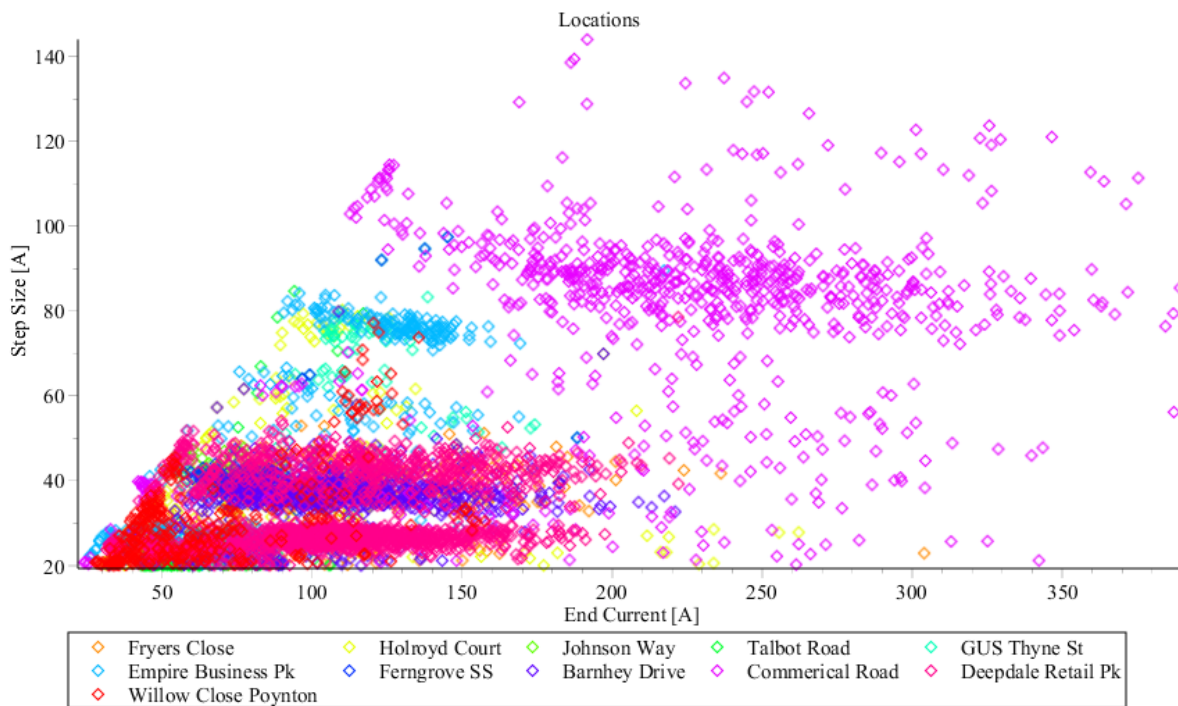

The results are much the same as before, although the maximum step size has now decreased from around 150 A to 144 A.

The data was also analysed for its location. Figure 10 shows the effect of domestic/non-domestic and Economy 7 on the step sizes.

Figure 10: Domestic/non-domestic and Economy 7 measured currents

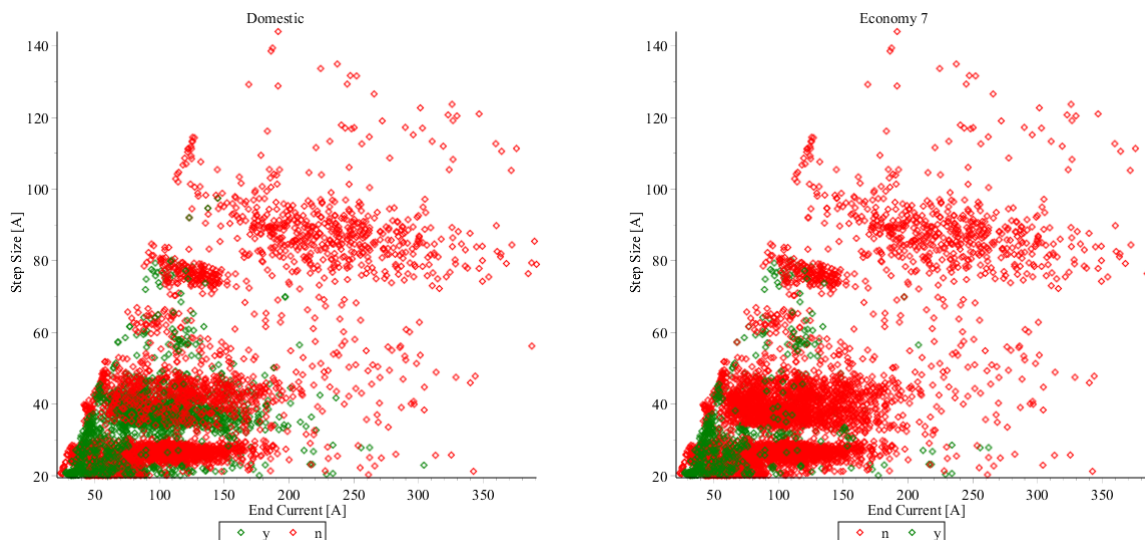

Here we can see that the majority of data recorded was non-domestic non-Economy 7. It is this group of installations that saw the largest step sizes. Unsurprisingly, non-domestic installations saw both the largest current draw and largest step size.

The results of this investigation have given a deeper insight into the steps in load current at a wide range of installations. The largest step sizes were of the order of 140 amps. This is particularly useful for setting up the long-range protection and being able to distinguish between fault and changes in load.

6.5 Directional protection

An algorithm has been developed for reliably detecting the direction of net real power flow in general 3-phase conditions. It uses only the current and phase-to-neutral voltage available to Kelvatek single-phase devices such as the Weezap and does not rely on communications with either of the two Weezaps on the other two corresponding phases, nor with the gateway etc.

The directional element has been used to enable 400A fuse emulation for forward faults but blocks protection in the reverse direction. This has been tested in a variety of scenarios using the simulation circuit developed to analyse the behaviour of meshed parallel feeders. There are two substations, 'L' on the left and 'R' on the right. There are also two parallel meshed feeders, '1' on top and '2' below. The circuit is shown in Figure 11, set up for a PN fault on L1, near Substation 'L'.

Figure 11: Simulation circuit for long-range protection

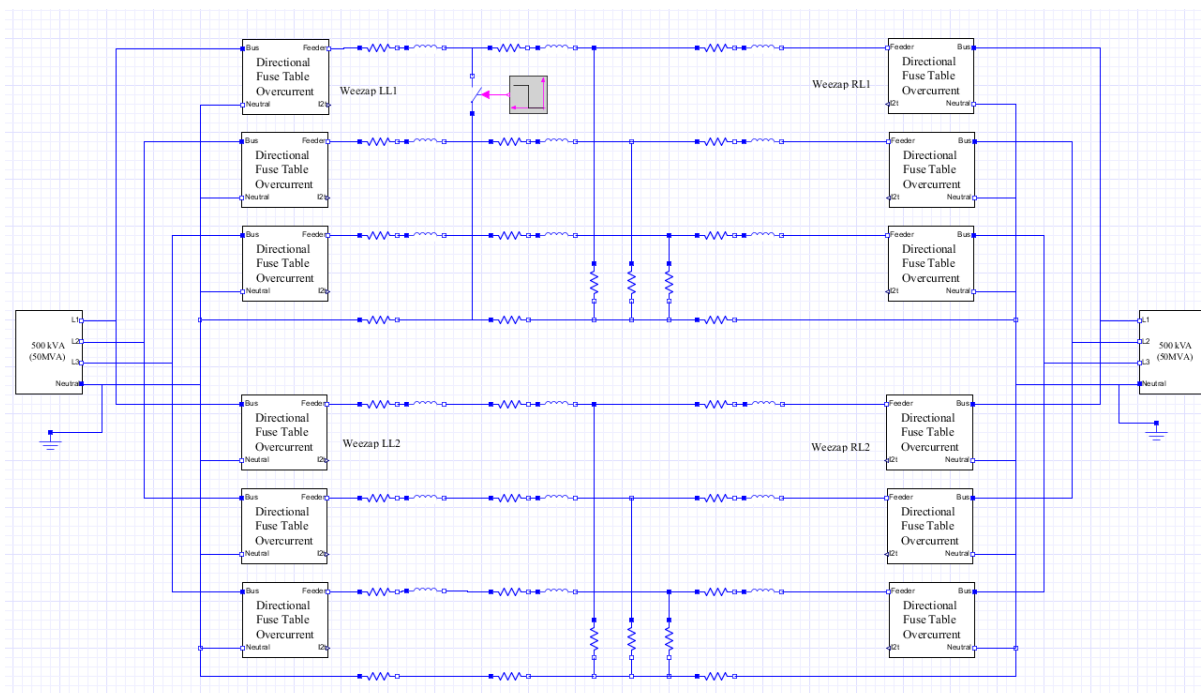

When the fault switch closes after 60ms settling time, fault current is supplied along phase L1 from both substations through both Weezap LL1 and Weezap RL1. Since the fault is much closer to Sub L, the fault current through Weezap LL1 is much higher.

This results in the bus of Sub L being pulled lower than that of Sub R, so that fault current also flows from Sub R to Sub L. Hence Weezap LL2 should see reverse power flow. The results of this PN fault on this meshed up feeder are shown in Figure 12; current and voltage of the Weezap feeding forward into the fault are given in the top pair of traces. The first three cycles are simply load current. When the fault occurs the current peaks at over 6000A and lasts for the next 4.5 cycles. Since Weezap LL1 saw this as a forward flow of power, its protection counter increments during this time (bottom plot, red) until it trips.

Meanwhile, the middle two traces show the current and voltage of Weezap LL2, in the same substation, on the same phase, but experiencing a reverse fault because it too is feeding a meshed up feeder connected to Sub R. It can be seen that the current is almost in antiphase with the voltage. This is correctly interpreted by the directional element, proved by the fact that its protection counter does not increment (bottom plot, green) all the time that Weezap LL1 is feeding the fault on feeder 1.

However, because both feeders are meshed up, the sequence does not stop when Weezap LL1 trips; at that point the voltage on the bus at Sub L is allowed to rise, resulting in power

now flowing from Sub L through Weezap LL2 in the forward direction, along feeder 2 to Sub R and back along feeder 1 to the fault. This now causes the protection counter in Weezap LL2 to begin incrementing, albeit slowly. Weezap RL1 would co-ordinate with Weezap LL2 to clear the fault on feeder 1 long before Weezap LL2 would reach its tripping point.

Figure 12: Simulation results for a phase to neutral fault

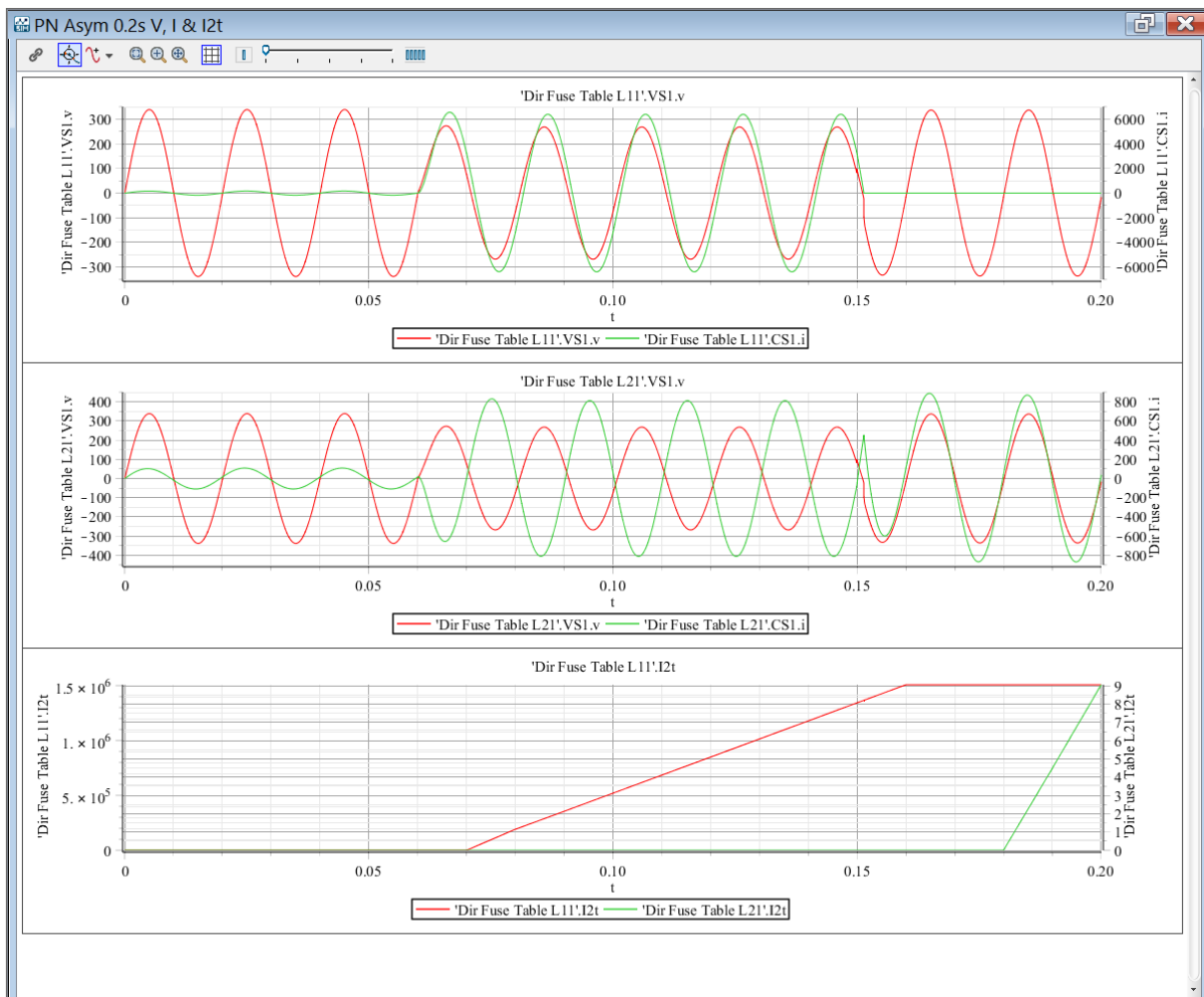

This demonstrates the operation of the directional protection in the relatively simple PN mode. A more complicated situation arises when a PP fault occurs. Using exactly the same circuit setup as per figure 11, the PN fault is now replaced with a PP fault bridging from L1 to L2.

The top oscillograph, in figure 13, shows current and voltage for Weezap L11, one of six Weezaps which should initially see a forward facing fault; the next two plots show results for Weezaps L21 and L22, the two which initially see a reverse flow of power. From the traces below it can be seen that in this case neither current is in exact antiphase with the voltage. However, the fourth plot shows the directional indicators: 1 represents forward fault, 0 means reverse. After the settling period all three see forward power, due to their load current, as expected. However, when the PP fault strikes only Weezap L11 (red) remains at 1, forward, while the other two both change to 0 indicating negative power flow.

Figure13: Simulation results for a phase to phase fault

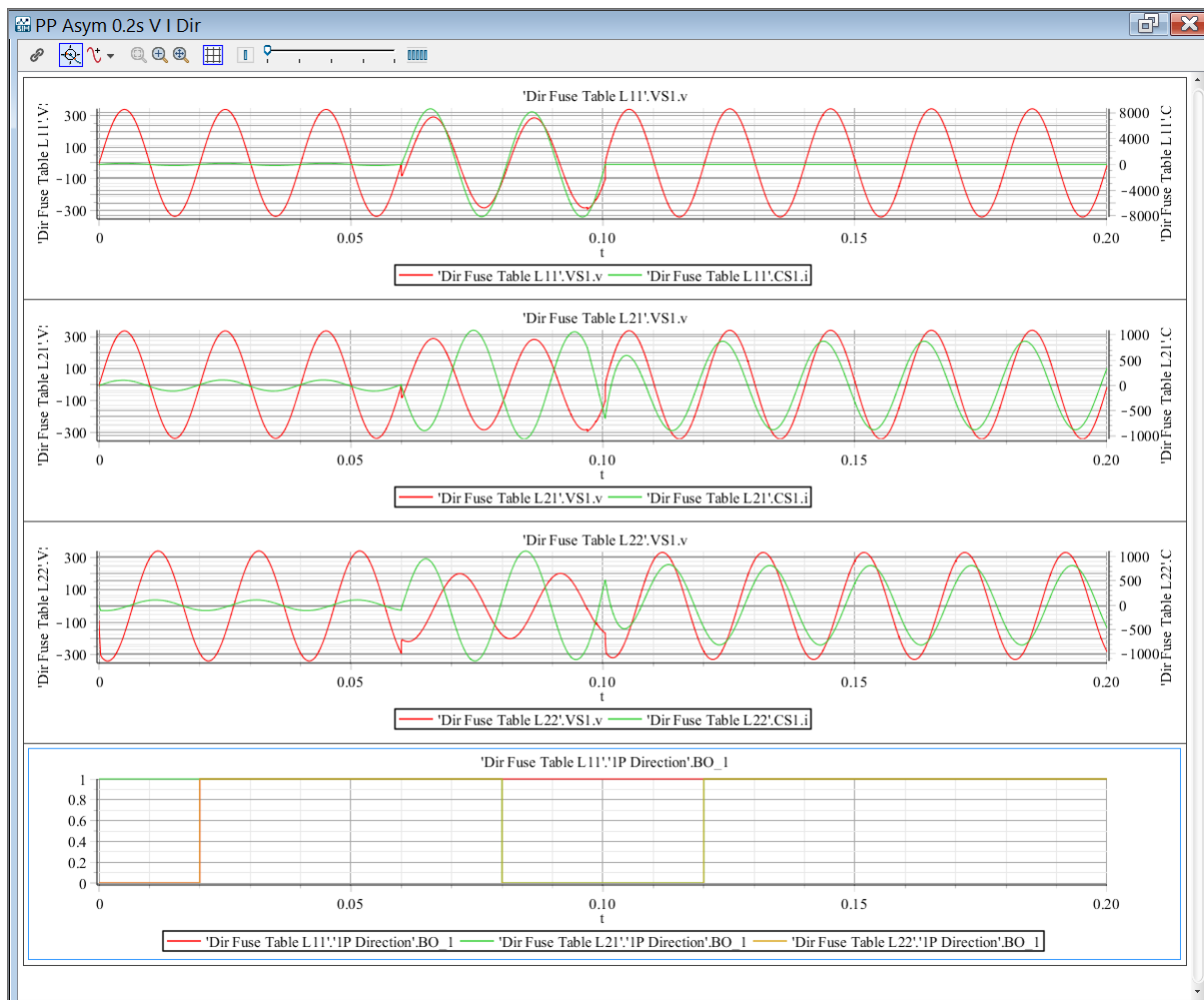

Once again this demonstrates correct behaviour.

PP faults are the most difficult in which to correctly determine the direction. PPN and 3P or 3PN do not produce such large phase swings and hence are easier.

6.6 Communications protocol

6.6.1 LV monitoring

A flexible scanning mechanism was implemented to bring in a number of signals from single and multiple devices on the LV network and make these visible to the control engineers. Alarms are generated to alert the engineers to any conditions and faults on the LV network.

Individual signals to be monitored can be selected using DNP3 messaging.

The devices can be reconfigured remotely from the Kelvatek central server. The gateways require the Kelvatek server to be available as this is their management. Unavailability of the server for long periods currently stops the scanning on a gateway. This does not affect the operation of the Weezap or Lynx only its ability to communicate that operation with CRMS.

6.6.2 System controls

Transient faults can be seen at the central system and action taken before the fault becomes permanent and customers lose supply.

A level of remote control has been given to the central system teams. Controls are only allowed from the CRMS, this is inhibited from the Kelvatek server system.

The central system restoration sequence can open and close devices to assist in restoring power.

7 PERFORMANCE COMPARED TO AIMS

7.1 The project will deliver a new set of protection functions which will allow greater protection of the future LV networks

The project has successfully developed the necessary algorithms for a range of protection functions including cold load pickup, long-range protection and directional protection. Each of these functionalities has been successfully demonstrated through simulation and testing. A number of devices have been installed on the Electricity North West network with the cold load pickup algorithm installed to help continue improvement. All of the new algorithms will be deployed in Weezaps being fitted as part of the Smart Street project.

7.2 The project will deliver the method to calculate the settings to be applied to the different network configurations

Kelvatek have developed a methodology for each of the protection algorithms which will allow the calculation of settings depending on network to be protected. These algorithms and associated settings are embedded within the software of the Weezap device and as such Kelvatek will perform the settings calculation and configuration. DNOs will need to provide Kelvatek with circuit parameters to allow this calculation.

7.3 The project will deliver a communications system to allow these to be altered remotely

The project has successfully implemented a DNP3 communications protocol between the Electricity North West control system and the Kelvatek gateway devices located in a substation or link box. This protocol has been fully tested to the Electricity North West test control system. Using this communications route the devices can be remotely opened or closed and software updates (including new protection settings) can be sent. The communications link also allows the collection of measurement data for both normal load and fault conditions which will permit further analysis to understand the operation of the LV network.

8 REQUIRED MODIFICATIONS

During the course of this project Electricity North West initiated a business as usual project to implement DNP3 communications to our distribution substations. This business as usual project was then able to offer efficiencies to LV PAC by including the majority of the IT element scoped as part of the First Tier spend. As a result the IT element of this project was de-scoped and these elements transferred to the business as usual project.

There were no modifications to the scope or outputs of the project and all aims were achieved at a lower cost.

9 VARIANCE IN COSTS AND BENEFITS

9.1 Costs variance

The original project budget was £746k but the final cost of the project was £458k. From the breakdown in table 3 it can be seen that the elements delivered with significant cost variances are IT and research support.

Table 3: Project cost summary

Item	Category	Estimated costs £k	Final costs £k rounded	Variance (%)
1	Programme & Project management	40	42	5.00
2	Project Technical Support	0	100	100
3	IT licence & support	252	40	-84.1
4	Research support - Kelvatek	454	276	-39.2
	Total	746	458	-57.1

The reduction in cost comes from:

- As detailed in section 8, a wider business as usual project implementing DNP3 protocols created efficiencies in LV PAC. Therefore in the IT category LV PAC was only required to pay for some specific licensing costs and associated support and the implementation was carried out as part of the wider business as usual project
- In the research support category the development of the protection algorithms and the DNP3 communications requirements were not as difficult as expected leading to a reduced development time and associated cost
- As part of research support category there was costs allowed to fully implement the protection algorithms. These algorithms were implemented at a much smaller scale and the large scale implementation will be carried out as part of the Second Tier project, Smart Street.

Internal technical support was not originally forecast. This was an oversight which has been corrected in future projects. The technical support involved providing the technical expertise to inform the algorithm development which included the provision of network data, analysis of fault types and anticipated issues associated with the uptake of heat pumps.

It should be noted that there is considerable difficulty associated with accurately forecasting the costs of projects such as LV PAC. This is in the main owing to the inherent uncertainty associated with the development of new algorithms and the amount of associated research required to support this activity.

9.2 Benefit variance

There is no benefit variance associated with this project as it successfully delivered on all the benefits predicted in the project registration.

The benefits of the project are enhanced protection and control functionality for LV networks for both radial and meshed configurations. The cold load pick protection is particularly aimed at catering for the expected increase in LCT installation.

The protection algorithms and communications protocols have been tested by simulation and on the Kelvatek test network. Electricity North West has deployed a limited number of devices with the cold load pickup algorithm enabled on the live distribution network.

10 LESSONS LEARNT

The project has successfully demonstrated enhanced protection functionality which can be applied to the Weezap devices. This enhanced functionality can provide greater protection for low level faults at the end of longer feeders and can protect against cold load pickup following a prolonged outage.

The project has successfully implemented DNP3 communications between the Kelvatek Weezap or Lynx devices and the Electricity North West control room management system. This communications link allows the remote control of the devices as well as transfer of measurement data from the device to the Kelvatek server for analysis.

During the communications element of the project a number of a number of issues came to light regarding the operation of the devices and their interaction with Electricity North West systems.

These included:

Remote setting of trips to lockout

Initially the trips to lockout could only be reset locally at the device. Modifications have been made to allow this to be carried out from the central system using DNP3 controls and a reset command.

Gateway boot up time

Following a loss of power the gateway can take up to 60 seconds to boot up and restore communications. Electricity North West has an automatic restoration programme to restore customer following a HV fault. This additional 60 seconds can create confusion for the programme and add significantly to the restoration times. To resolve this Kelvatek are developing a battery backup is being developed for the gateway.

11 PLANNED IMPLEMENTATION

The communications routes developed as part of this project will be used to remotely talk to all the Weezap and Lynx devices being deployed as part of the Second Tier project, Smart Street.

The protection algorithms will be deployed in selected devices being deployed as part of the Second Tier project, Smart Street. This will allow Kelvatek to monitor the operation of the algorithms and make any improvements to their functionality.

12 FACILITATE REPLICATION

All of the protection algorithms and communications protocols developed as part of LV PAC will be commercially available on the Weezap and Lynx platforms. Any combination of the algorithms can be used to meet the individual DNO's requirements.

APPENDIX 1: SIMPLIFIED CIRCUIT MODEL LONG RANGE PROTECTION SIMULATION RESULTS

The figures below show several of the cases investigated using the simplified circuit model for verifying the behaviour of the long-range protection.

The 'coverage plots' in show the protection status of different parts of the hypothetical network as the fault is moved from the substation towards the link box, and the branch containing the fault is lengthened from zero length (corresponding to the fault being on the main) to a high resistance branch. Green regions show areas of the network that would be covered by the long-range protection algorithms, while red regions show those which are not covered. Yellow regions have coverage, but a manual trip of a Weezap in the meshed configuration could cause tripping of one of the other devices in the network due to load being supplied from the other substation. The normal operating policy is such that the Lynx is tripped before tripping any Weezap to avoid this. Darker shaded areas are those which would be covered by a fuse of the specified rating.

Case 1: High resistance main, high load current, 400A fuse setting

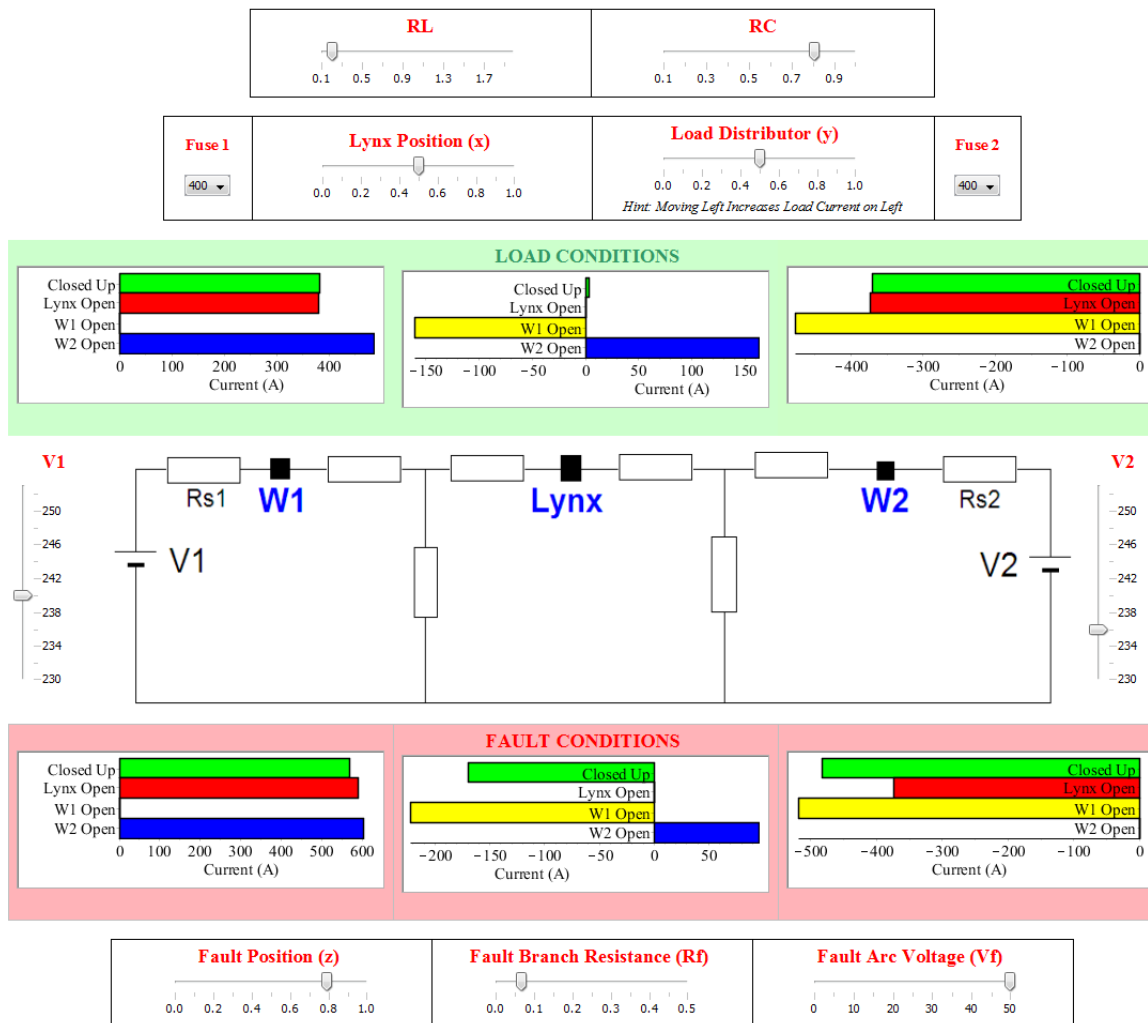

At 39.s, LYNX trips on long-range protection

At 99.s, WZP1 trips based on low set

Network state after 100s:

- WZP1 : OPEN
- LYNX : OPEN
- WZP2 : CLOSED

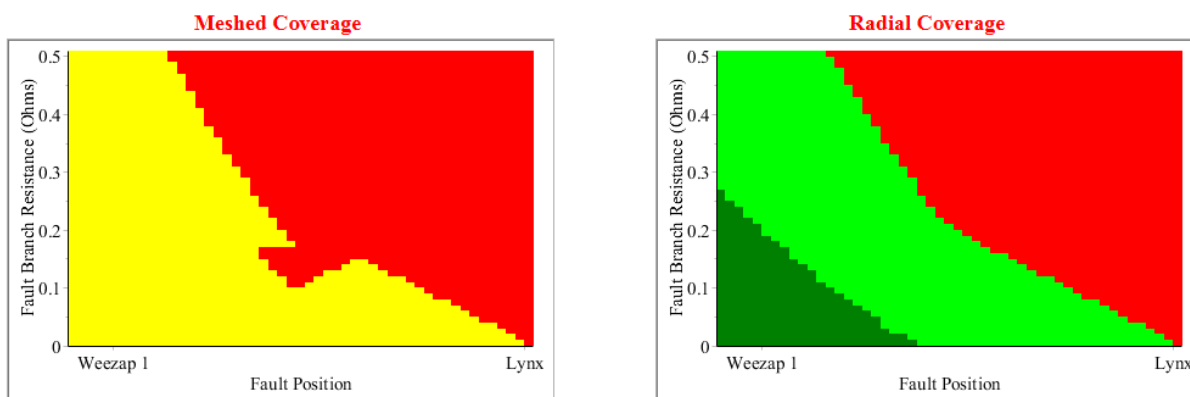

We can see that in the meshed scenario for this network, a conventional fuse would not isolate a permanent fault, whereas the long-range protection algorithms offer a significant level of protection, extending almost to the link box. In the radial scenario, the long-range protection offers significant coverage above that offered by a conventional fuse.

Case 2: High resistance main, low load current, 400A fuse setting

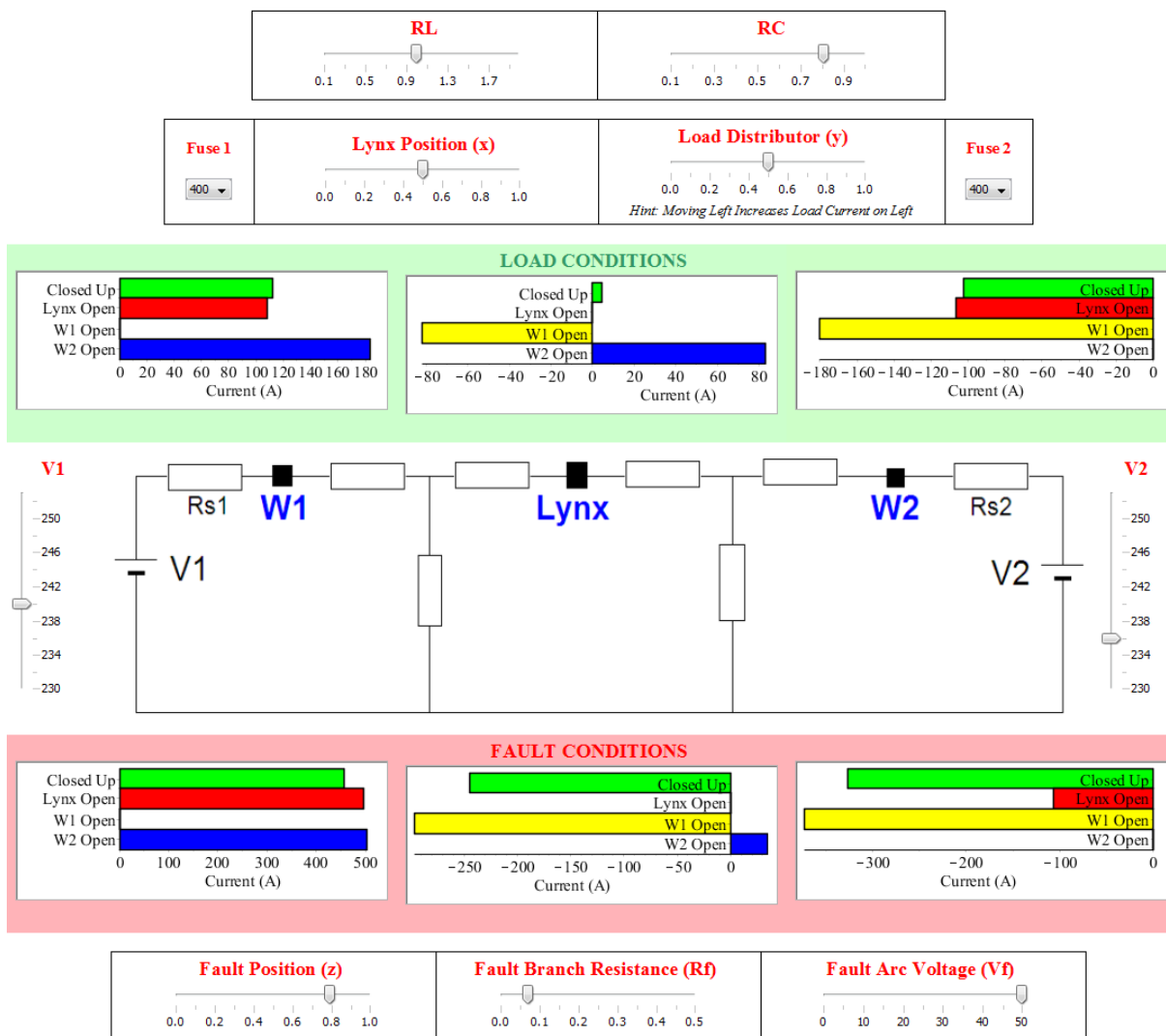

At 39.s, LYNX trips on long-range protection
 At 49.s, WZP1 trips on long-range protection
 Network state after 100s:
 WZP1 : OPEN
 LYNX : OPEN
 WZP2 : CLOSED

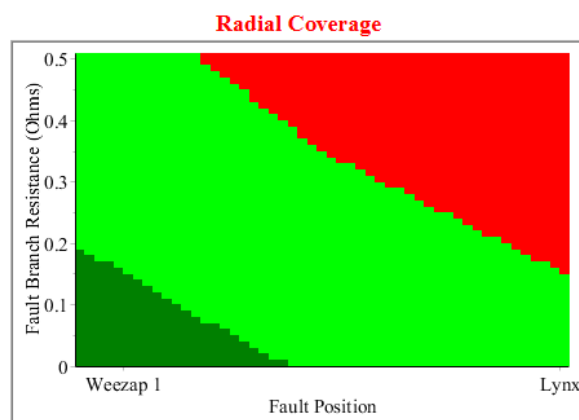
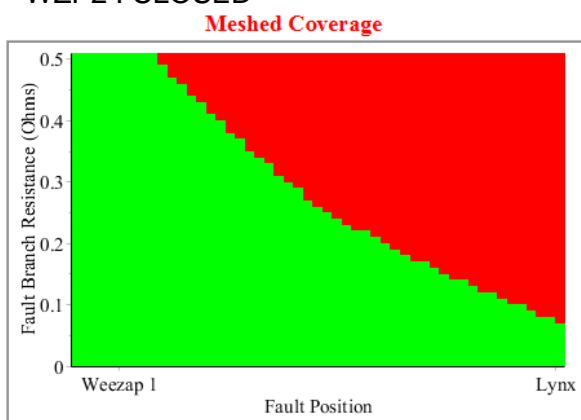

In the low load current example, we can see that the coverage is extended to the link box, and also that manually tripping a Weezap will not cause the Lynx to trip erroneously due to a change in load current direction as the area is green rather than yellow. Again, a conventional fuse would provide no coverage for the meshed scenario.

Case 3: Low resistance main, high load current, 400A fuse setting

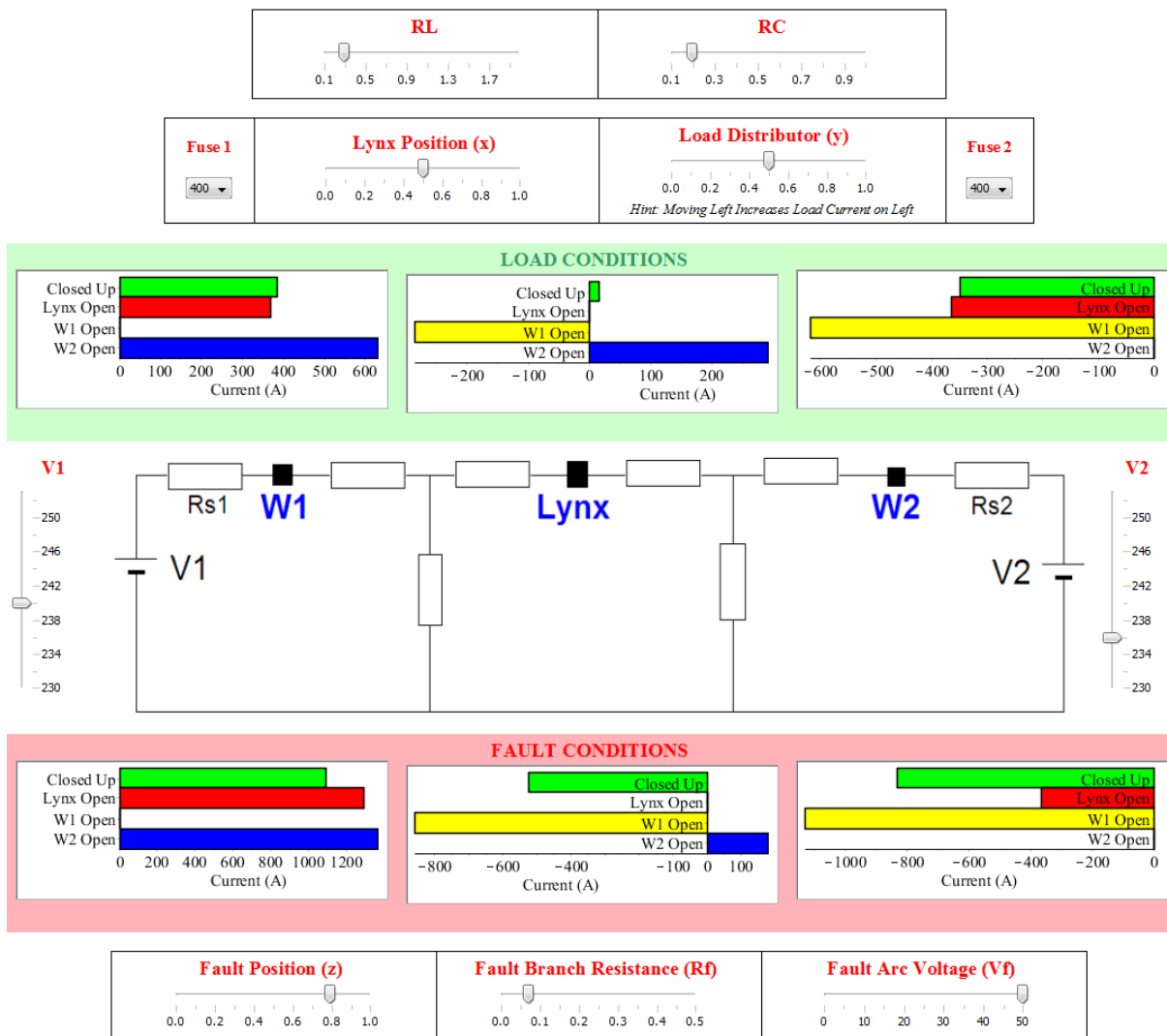

At 39.s, LYNX trips on long-range protection

At 47.s, WZP1 trips based on fuse curve

Network state after 100s:

WZP1 : OPEN

LYNX : OPEN

WZP2 : CLOSED

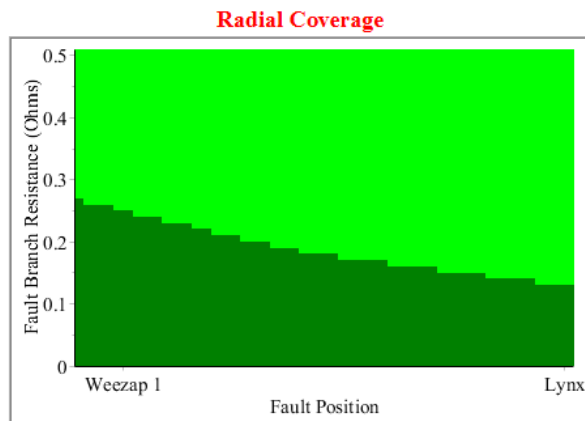
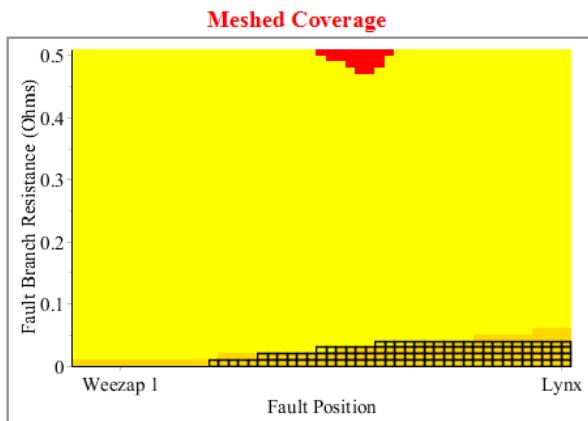

In this network, with a smaller cable resistance between the two link boxes, we see that the fuse could provide some coverage to the main, although branches of significant resistance would not be covered. The long-range protection offers a large extension to the coverage.

The black boxes indicate regions where both Weezaps would trip due to the high fault current seen through each device, which is resolved by the automatic reclosing of the Weezaps with the Lynx having radialised the network.

APPENDIX 2: TRANSIENT LOAD SURVEY

The transient load survey recorded the step increases in current level at a number of different locations. The data was used to determine typical step sizes, current levels and frequency of steps. The results may be presented in a number of ways, such as the following step size to start current plot:

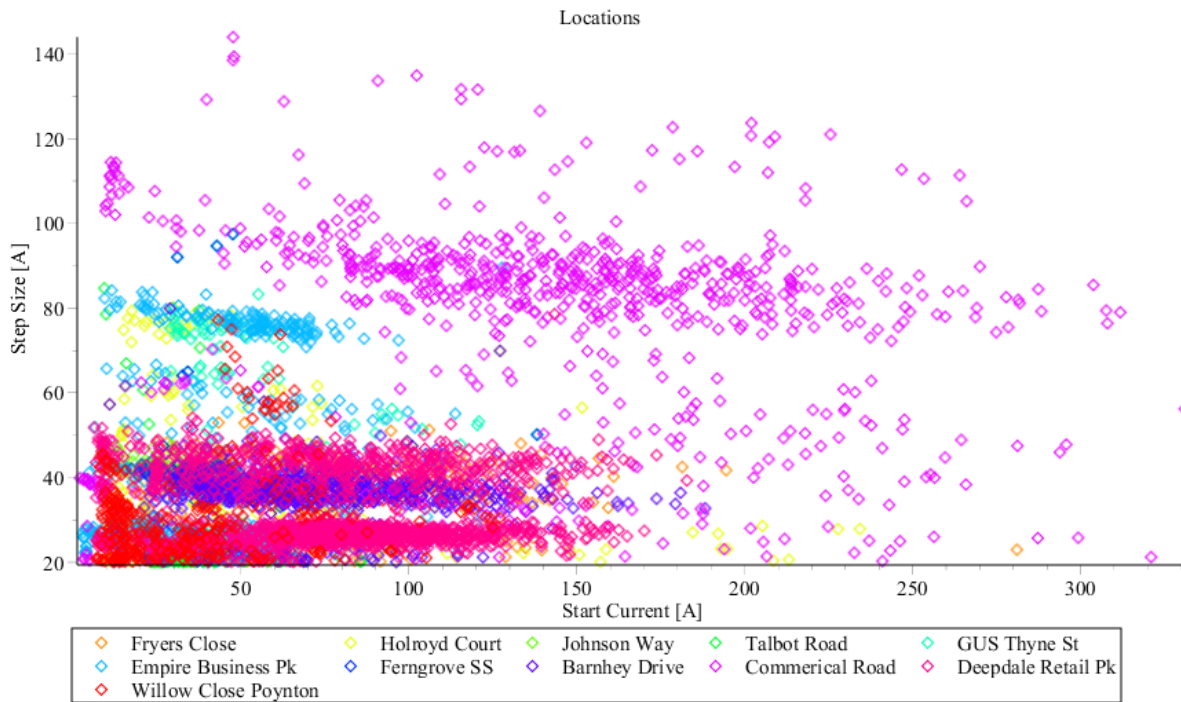

From this plot it can be seen that the majority of starting currents were below 150 amps. There is also a notable lack of large step sizes at high starting current levels. At these high start current levels, the feeder already has most connected loads drawing current, thus there are few remaining large loads to be connected.

Alternatively we can plot the relationship between the decay in the step current and the step size:

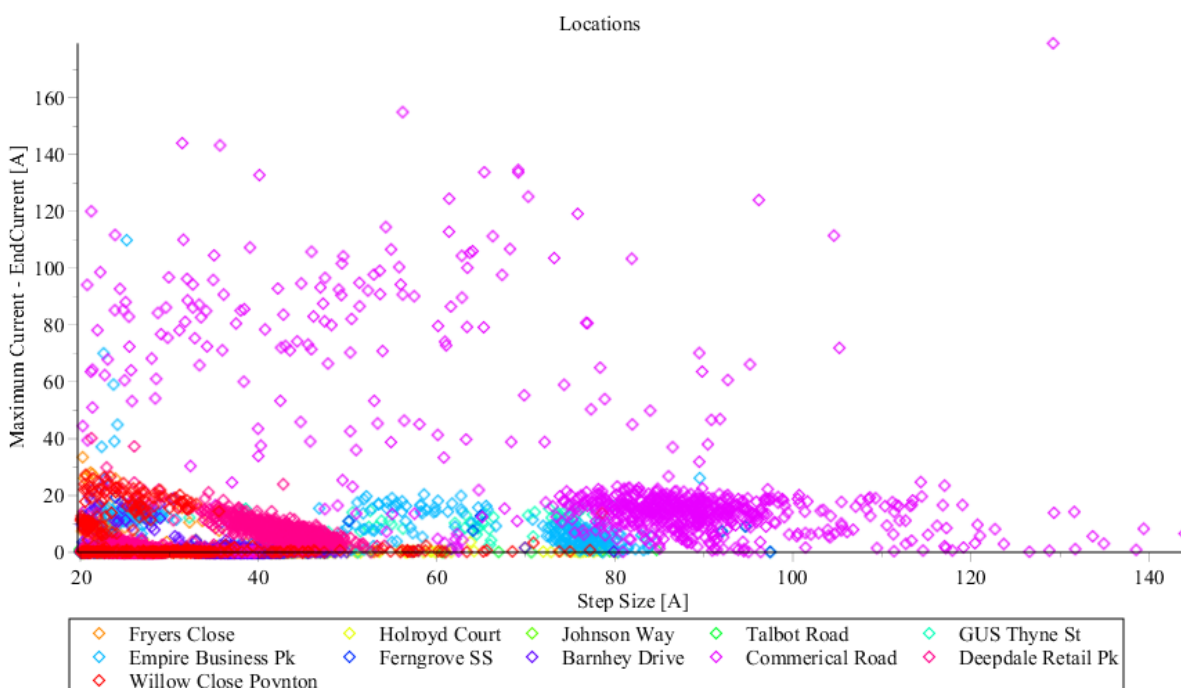

The cluster of data in the bottom left corner is from relatively small loads that either briefly draw current or quickly reduce their current draw after switch-on. There is also a sizable cluster of points that show large loads switching on, with relatively small changes in the variation of the current draw (bottom centre and bottom right). Most large current steps have relatively small decays in current. The exception is the diffuse region of points from Commercial Road which is due to loads that have a large decay in their current level after switch-on. This is likely due to the inrush from heavy machinery.

APPENDIX 3: BORSDANE AVENUE – BRIDGEWATER STREET CURRENTS AND VOLTAGES IN LOAD AND FAULT SCENARIOS.

To demonstrate the behaviour of the long-range protection on a real-world example, a network from the Smart Street area was analysed in detail using a custom network analysis tool. Several fault locations were investigated across the network, and the long-range protection was run on each.

The following section shows the results for the Bridgewater-Borsdane network when simulated using the Kelvatek Network Explorer program. The current and voltage is estimated during load and fault, and during load only at both substations (Weezaps) and the link-box (Lynx). Results whilst the link-box is open and closed are calculated. The calculations are based on the parameters used in Electricity North West LV Affirm.

Note that the voltage at the Lynx is the voltage on the Bridgewater side of the link-box (this is why the voltage is not zero when the Lynx is open). Due to the method of calculation, current through an open link-box is not exactly zero.

The locations of the faults on the network are shown in the figure below.

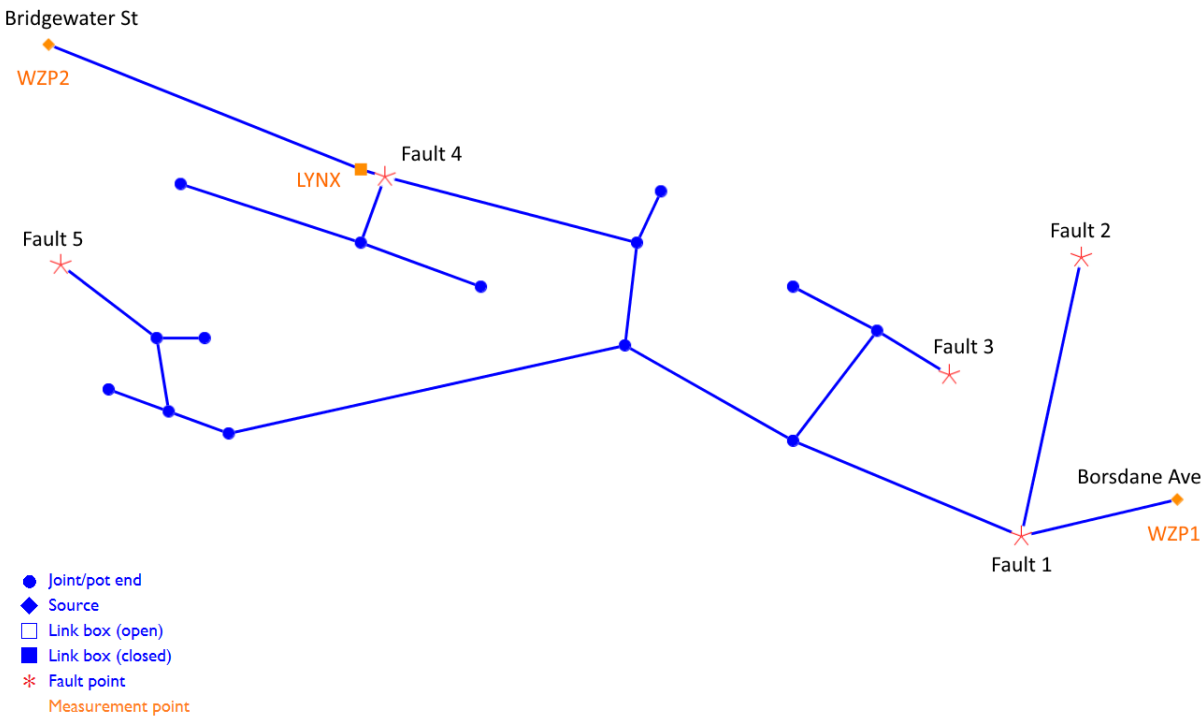

The output of the protection algorithms are shown below for each fault. In every case, the combination of protection algorithms is able to isolate the fault, within 100s, while maintaining customer connection at the Bridgewater Street side of the link box.

Fault 1:

At 0.s, WZP1 trips based on fuse curve
At 39.s, LYNX trips on long-range protection
Network state after 100s:
WZP1 : OPEN
LYNX : OPEN
WZP2 : CLOSED

Fault 2:

At 0.s, WZP1 trips based on fuse curve
At 39.s, LYNX trips on long-range protection
Network state after 100s:
WZP1 : OPEN
LYNX : OPEN
WZP2 : CLOSED

Fault 3:

At 39.s, LYNX trips on long-range protection
At 52.s, WZP1 trips based on fuse curve
Network State after 100s:
WZP1 : OPEN
LYNX : OPEN
WZP2 : CLOSED

Fault 4:

At 39.s, LYNX trips on long-range protection
At 41.s, WZP1 trips based on fuse curve
Network state after 100s:
WZP1 : OPEN
LYNX : OPEN
WZP2 : CLOSED

Fault 5:

At 39.s, LYNX trips on long-range protection
At 59.s, WZP1 trips on long-range protection
Network state after 100s:
WZP1 : OPEN
LYNX : OPEN
WZP2 : CLOSED